

Fire Alarm Control Panel
MS-5210UD/MS-5210UDE

Fire Alarm System Limitations

An automatic fire alarm system—typically made up of smoke detectors, heat detectors, manual pull stations, audible warning devices, and a fire alarm control with remote notification capability—can provide early warning of a developing fire. Such a system, however, does not assure protection against property damage or loss of life resulting from a fire.

The Manufacturer recommends that smoke and/or heat detectors be located throughout a protected premise following the recommendations of the current edition of the National Fire Protection Association Standard 72 (NFPA 72), manufacturer's recommendations, State and local codes, and the recommendations contained in the Guide for Proper Use of System Smoke Detectors, which is made available at no charge to all installing dealers. A study by the Federal Emergency Management Agency (an agency of the United States government) indicated that smoke detectors may not go off in as many as 35% of all fires. While fire alarm systems are designed to provide early warning against fire, they do not guarantee warning or protection against fire. A fire alarm system may not provide timely or adequate warning, or simply may not function, for a variety of reasons:

Smoke detectors may not sense fire where smoke cannot reach the detectors such as in chimneys, in or behind walls, on roofs, or on the other side of closed doors. Smoke detectors also may not sense a fire on another level or floor of a building. A second-floor detector, for example, may not sense a first-floor or basement fire.

Particles of combustion or "smoke" from a developing fire may not reach the sensing chambers of smoke detectors because:

- Barriers such as closed or partially closed doors, walls, or chimneys may inhibit particle or smoke flow.
- Smoke particles may become "cold," stratify, and not reach the ceiling or upper walls where detectors are located.
- Smoke particles may be blown away from detectors by air outlets.
- Smoke particles may be drawn into air returns before reaching the detector.

The amount of "smoke" present may be insufficient to alarm smoke detectors. Smoke detectors are designed to alarm at various levels of smoke density. If such density levels are not created by a developing fire at the location of detectors, the detectors will not go into alarm.

Smoke detectors, even when working properly, have sensing limitations. Detectors that have photoelectronic sensing chambers tend to detect smoldering fires better than flaming fires, which have little visible smoke. Detectors that have ionizing-type sensing chambers tend to detect fast-flaming fires better than smoldering fires. Because fires develop in different ways and are often unpredictable in their growth, neither type of detector is necessarily best and a given type of detector may not provide adequate warning of a fire.

Smoke detectors cannot be expected to provide adequate warning of fires caused by arson, children playing with matches (especially in bedrooms), smoking in bed, and violent explosions (caused by escaping gas, improper storage of flammable materials, etc.).

While a fire alarm system may lower insurance rates, it is not a substitute for fire insurance!

Heat detectors do not sense particles of combustion and alarm only when heat on their sensors increases at a predetermined rate or reaches a predetermined level. Rate-of-rise heat detectors may be subject to reduced sensitivity over time. For this reason, the rate-of-rise feature of each detector should be tested at least once per year by a qualified fire protection specialist. *Heat detectors are designed to protect property, not life.*

IMPORTANT! Smoke detectors must be installed in the same room as the control panel and in rooms used by the system for the connection of alarm transmission wiring, communications, signaling, and/or power. If detectors are not so located, a developing fire may damage the alarm system, crippling its ability to report a fire.

Audible warning devices such as bells may not alert people if these devices are located on the other side of closed or partly open doors or are located on another floor of a building. Any warning device may fail to alert people with a disability or those who have recently consumed drugs, alcohol or medication. Please note that:

- Strobes can, under certain circumstances, cause seizures in people with conditions such as epilepsy.
- Studies have shown that certain people, even when they hear a fire alarm signal, do not respond or comprehend the meaning of the signal. It is the property owner's responsibility to conduct fire drills and other training exercise to make people aware of fire alarm signals and instruct them on the proper reaction to alarm signals.
- In rare instances, the sounding of a warning device can cause temporary or permanent hearing loss.

A fire alarm system will not operate without any electrical power. If AC power fails, the system will operate from standby batteries only for a specified time and only if the batteries have been properly maintained and replaced regularly.

Equipment used in the system may not be technically compatible with the control. It is essential to use only equipment listed for service with your control panel.

Telephone lines needed to transmit alarm signals from a premise to a central monitoring station may be out of service or temporarily disabled. For added protection against telephone line failure, backup radio transmission systems are recommended.

The most common cause of fire alarm malfunction is inadequate maintenance. To keep the entire fire alarm system in excellent working order, ongoing maintenance is required per the manufacturer's recommendations, and UL and NFPA standards. At a minimum, the requirements of Chapter 7 of NFPA 72 shall be followed. Environments with large amounts of dust, dirt or high air velocity require more frequent maintenance. A maintenance agreement should be arranged through the local manufacturer's representative. Maintenance should be scheduled monthly or as required by National and/or local fire codes and should be performed by authorized professional fire alarm installers only. Adequate written records of all inspections should be kept.

Installation Precautions

WARNING - Several different sources of power can be connected to the fire alarm control panel. Disconnect all sources of power before servicing. Control unit and associated equipment may be damaged by removing and/or inserting cards, modules, or interconnecting cables while the unit is energized. Do not attempt to install, service, or operate this unit until this manual is read and understood.

CAUTION - *System Reacceptance Test after Software Changes.* To ensure proper system operation, this product must be tested in accordance with NFPA 72 Chapter 7 after any programming operation or change in site-specific software. Reacceptance testing is required after any change, addition or deletion of system components, or after any modification, repair or adjustment to system hardware or wiring.

All components, circuits, system operations, or software functions known to be affected by a change must be 100% tested. In addition, to ensure that other operations are not inadvertently affected, at least 10% of initiating devices that are not directly affected by the change, up to a maximum of 50 devices, must also be tested and proper system operation verified.

This system meets NFPA requirements for operation at 0-49° C/32-120° F and at a relative humidity of 85% RH (non-condensing) at 30° C/86° F. However, the useful life of the system's standby batteries and the electronic components may be adversely affected by extreme temperature ranges and humidity. Therefore, it is recommended that this system and all peripherals be installed in an environment with a nominal room temperature of 15-27° C/60-80° F.

Verify that wire sizes are adequate for all initiating and indicating device loops. Most devices cannot tolerate more than a 10% I.R. drop from the specified device voltage.

Adherence to the following will aid in problem-free installation with long-term reliability:

Like all solid state electronic devices, this system may operate erratically or can be damaged when subjected to lightning-induced transients. Although no system is completely immune from lightning transients and interferences, proper grounding will reduce susceptibility. *Overhead or outside aerial wiring is not recommended, due to an increased susceptibility to nearby lightning strikes.* Consult with the Technical Services Department if any problems are anticipated or encountered.

Disconnect AC power and batteries prior to removing or inserting circuit boards. Failure to do so can damage circuits.

Remove all electronic assemblies prior to any drilling, filing, reaming, or punching of the enclosure. When possible, make all cable entries from the sides or rear. Before making modifications, verify that they will not interfere with battery, transformer, and printed circuit board location.

Do not tighten screw terminals more than 9 in-lbs. Over-tightening may damage threads, resulting in reduced terminal contact pressure and difficulty with screw terminal removal.

Though designed to last many years, system components can fail at any time. This system contains static-sensitive components. Always ground yourself with a proper wrist strap before handling any circuits so that static charges are removed from the body. Use static-suppressive packaging to protect electronic assemblies removed from the unit.

Follow the instructions in the installation, operating, and programming manuals. These instructions must be followed to avoid damage to the control panel and associated equipment. FACP operation and reliability depend upon proper installation by authorized personnel.

FCC Warning

WARNING: This equipment generates, uses, and can radiate radio frequency energy and if not installed and used in accordance with the instruction manual, may cause interference to radio communications. It has been tested and found to comply with the limits for class A computing device pursuant to Subpart B of Part 15 of FCC Rules, which is designed to provide reasonable protection against such interference when operated in a commercial environment.

Operation of this equipment in a residential area is likely to cause interference, in which case the user will be required to correct the interference at his own expense.

Notes

Table of Contents

CHAPTER 1: Product Description	11
1.1: Product Features	11
FIGURE 1-1: Optional DP-5210UD.....	12
FIGURE 1-2: MS-5210UD Panel.....	13
1.2: Specifications	14
1.3: Controls and Indicators	15
FIGURE 1-3: Display and Keypad.....	15
1.4: Circuits	15
1.5: Digital Communicator.....	16
1.6: Components.....	17
FIGURE 1-4: Transformer Assemblies	17
1.7: Optional Modules.....	18
1.8: Optional Accessories.....	18
FIGURE 1-5: BB-17F Battery Box	18
FIGURE 1-6: LED-10 Series Annunciator.....	19
FIGURE 1-7: ACM-16ATF.....	19
FIGURE 1-8: AFM-16ATF	20
FIGURE 1-9: AFM-16AF.....	20
FIGURE 1-10: LDM-32F Module.....	20
FIGURE 1-11: FCPS-24F(E).....	21
1.9: Telephone Requirements and Warnings	22
1.9.1: Telephone Circuitry:.....	22
1.9.2: Digital Communicator:	22
1.9.3: Telephone Company Rights and Warnings:	22
CHAPTER 2: Installation.....	23
2.1: Mounting Options	23
2.2: Backbox Mounting.....	23
FIGURE 2-1: Cabinet Dimensions and Knockout Locations.....	24
FIGURE 2-2: FACP Backbox and Battery Box	25
2.3: Operating Power.....	26
FIGURE 2-3: Operating Power Connections.....	26
2.4: Input Circuits.....	27
FIGURE 2-4: Style B Initiating Device Circuit Connections.....	28
2.5: Output Circuits	28
FIGURE 2-5: Auxiliary Power Connections	28
FIGURE 2-6: Notification Appliance Circuit Connections.....	29
FIGURE 2-7: Programmable Relay Terminals.....	29
2.6: Digital Communicator.....	30
FIGURE 2-8: Wiring Phone Jacks.....	30
2.7: UL Power-limited Wiring Requirements	31
FIGURE 2-9: Typical Wiring Diagram for UL Power-limited Requirements	31
2.8: Installation of Optional Modules.....	32
FIGURE 2-10: Installation of CAC-10F Module	32
FIGURE 2-11: Wiring NACs and IDCs for Class A Operation.....	32
FIGURE 2-12: Installation & Wiring of NAC-REM Module	33
FIGURE 2-13: Remote Printer Connections	34
TABLE 2-1: Printer Settings.....	34
FIGURE 2-14: LED-10IM Installation.....	35
FIGURE 2-15: Wiring LED-10IM to LED-10 Series	35
FIGURE 2-16: ABS-8R Enclosure	36
FIGURE 2-17: Wiring LED-10IM to ACM-8RF	36
FIGURE 2-18: Wiring LED-10IM to LDM-32F.....	37

Table of Contents

FIGURE 2-19: Wiring LED-10IM to ACM-16ATF 38

CHAPTER 3: Programming Instructions 39

3.1: Entering Program Mode 39

3.2: Switch Functions 40

 FIGURE 3-1: Control Panel Keypad 40

3.3: Program Options 40

 3.3.1: Level 1 - Main Panel Options 40

 TABLE 3-1: Zone Functions 44

 TABLE 3-2: Event Code Changes for ID Contact Format 46

 FIGURE 3-2: Verification Timing Diagram 47

 3.3.2: Level Two - Event Codes/Transmission Formats 49

 TABLE 3-3: Event Codes, Primary Central Station Number 50

 TABLE 3-4: Event Codes, Primary Central Station Number 52

 TABLE 3-5: Event Codes, Primary Central Station Number 54

 TABLE 3-6: Event Codes, Secondary Central Station Number 55

 TABLE 3-7: Event Codes, Secondary Central Station Number 57

 TABLE 3-8: Event Codes, Secondary Central Station Number 59

 3.3.3: Level Three - Option Module Selections 60

 3.3.4: Level Four - Upload/Download Option 62

 3.3.5: Default Programming 64

CHAPTER 4: Operating Instructions 65

 FIGURE 4-1: New and Old Keypad/Display 65

4.1: Switch Functions in Normal Mode 65

4.2: LED Display and Status LEDs 67

 FIGURE 4-2: Phone Connectors and LEDs 68

4.3: Operation 69

 4.3.1: Fire Alarm Response 69

 4.3.2: Fire Alarm Restoral 70

 4.3.3: System Supervisory Condition Response 70

 4.3.4: System Supervisory Restoral Response 70

 4.3.5: Trouble Condition Response 71

 4.3.6: Trouble Condition Restoral 71

 4.3.7: Process Monitored Alarm Response 72

 4.3.8: Process Monitored Alarm Restoral 72

 4.3.9: OFF Normal Reporting 72

 4.3.10: Zone Disable/Enable 72

 4.3.11: NAC (bell) Disable/Enable 73

 4.3.12: Fire Drill 73

4.4: Central Station Communications 74

 TABLE 4-1: Format Selection Addresses (16+42) Programming Level 1 75

 TABLE 4-2: Format Selection Address Explanation 76

 4.4.1: Transmittal Priorities 77

 TABLE 4-3: Compatible UL Listed Receivers 78

CHAPTER 5: Servicing 79

5.1: Walk Test Mode 79

5.2: History Mode 80

 TABLE 5-1: History Mode Messages 81

5.3: Troubleshoot Mode 82

 5.3.1: Zones 82

 5.3.2: AC Line 83

 5.3.3: Battery 83

 5.3.4: Telephone Lines 83

Table of Contents

FIGURE 5-1: Handset/Speaker Connection 83

5.3.5: NACs 1, 2, 3 and 4 84

5.3.6: Resettable Power 84

5.4: Lamp Test 84

5.5: Print Mode 84

5.6: Printer Output 85

CHAPTER 6: Remote Site Upload/Download 86

6.1: Downloading Program: General 86

6.1.1: Security Features 87

6.2: Downloading Initiated at Control Panel 88

6.3: Downloading Initiated at a Service Terminal 89

6.4: Uploading Initiated at a Service Terminal 89

6.5: Simultaneous Data Transfers 90

Appendix A: Battery Calculations 91

TABLE A-1: Battery Calculation 91

A.1: Main Power Supply 92

TABLE A-2: Regulated Load in Standby @24 VDC , 92

TABLE A-3: Regulated Load in Alarm @24 VDC , 93

Appendix B: Main Panel Options Program Sheets 94

Appendix C: Event Codes/Transmission Format Programming Sheets 99

Appendix D: Ademco Contact ID Format Event Code Descriptions 109

Appendix E: Option Modules Programming Sheets 114

Appendix F: Upload/Download Program Sheets 116

Appendix G: Wire Requirements 117

TABLE 6-1: Wire Requirements 117

Appendix H: Operation and Function Modes 118

TABLE 6-2: OPERATION MODES 118

TABLE 6-3: FUNCTION MODES 118

Notes

This control panel has been designed to comply with standards set forth by the following regulatory agencies:

- Underwriters Laboratories Standard UL 864
- NFPA 72 National Fire Alarm Code

Before proceeding, the installer should be familiar with the following documents.



NFPA Standards

This Fire Alarm Control Panel complies with the following NFPA Standards:

NFPA 72 National Fire Alarm Code for Central Station Signaling Systems Protected Premises Unit (Automatic, Manual and Waterflow), Local Fire Alarm Systems and Remote Station Fire Alarm Systems.



Underwriters Laboratories Documents:

- UL 38 Manually Actuated Signaling Boxes
- UL 217 Smoke Detectors, Single and Multiple Station
- UL 228 Door Closers-Holders for Fire Protective Signaling Systems
- UL 268 Smoke Detectors for Fire Protective Signaling Systems
- UL 268A Smoke Detectors for Duct Applications
- UL 346 Waterflow Indicators for Fire Protective Signaling Systems
- UL 464 Audible Signaling Appliances
- UL 521 Heat Detectors for Fire Protective Signaling Systems
- UL 864 Standard for Control Units for Fire Protective Signaling Systems
- UL 1481 Power Supplies for Fire Protective Signaling Systems
- UL 1638 Visual Signaling Appliances
- UL 1971 Signaling Devices for Hearing Impaired

Other:

- NEC Article 250 Grounding
- NEC Article 300 Wiring Methods
- NEC Article 760 Fire Protective Signaling Systems
- Applicable Local and State Building Codes
- Requirements of the Local Authority Having Jurisdiction (LAHJ)

Fire•Lite Documents

- | | |
|--|-----------------|
| Fire•Lite Device Compatibility Document | Document #15384 |
| Annunciator Modules | Document #15390 |
| AFM-16ATF Annunciator | Document #15970 |
| AFM-16AF Annunciator | Document #15210 |
| FCPS-24F Field Charger/Power Supply | Document #50079 |
| LDM Series Lamp Driver Modules | Document #50055 |
| LED-10 Annunciator | Document #50400 |
| ACM-8RF Annunciator Control Relay Module | Document #50362 |
| PK-5210UD Manual | Document #50363 |

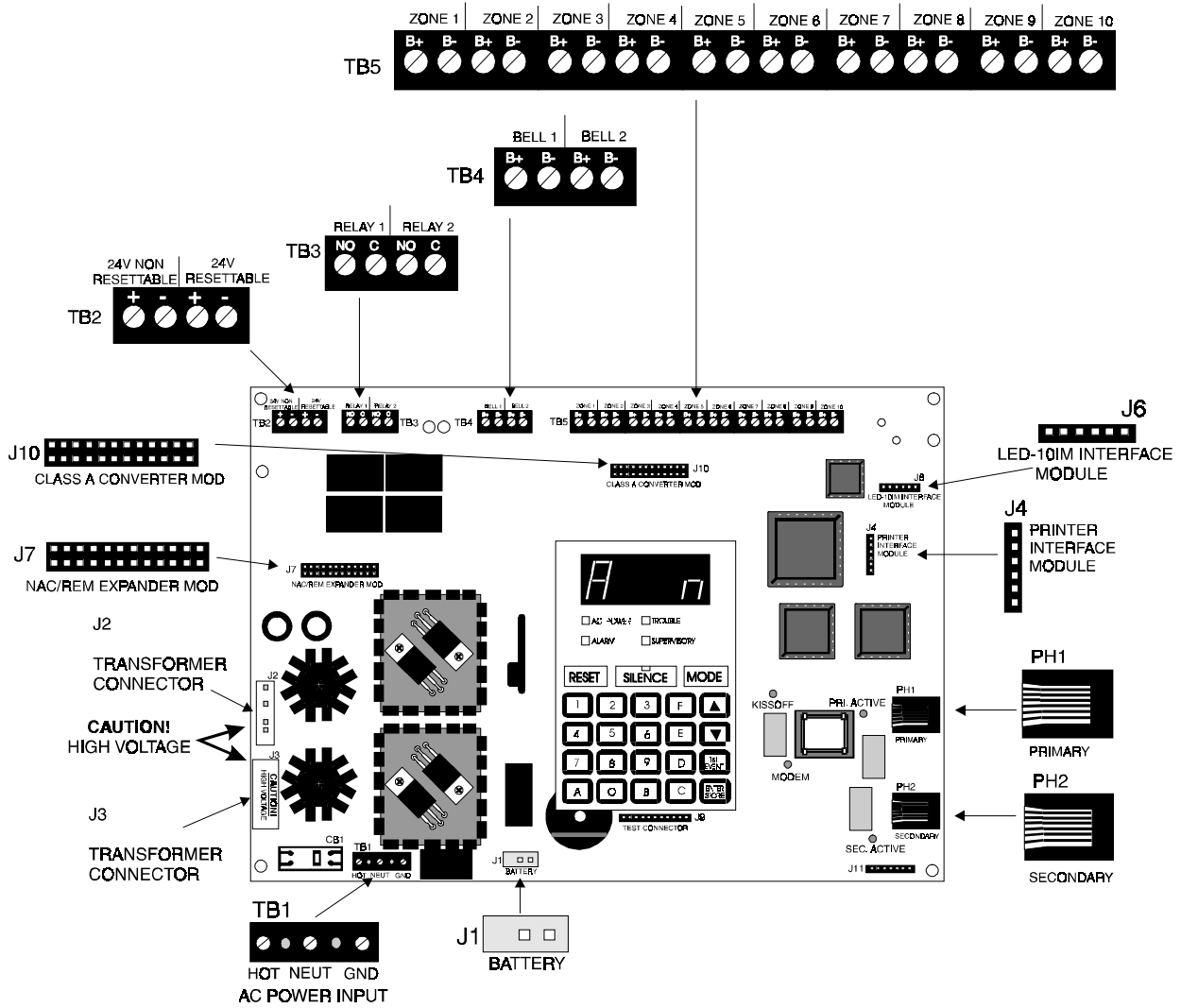

MS-5210UD Terminals and Connectors

CHAPTER 1 *Product Description*

The MS-5210UD is a combination control panel and digital communicator all on one circuit board. It is a 10-zone panel, which uses conventional input devices. The panel accepts waterflow devices, two-wire smoke detectors, four-wire smoke detectors, pull stations and other normally-open contact devices. Outputs include two Notification Appliance Circuits (NACs) expandable to four, two programmable Form-A relays (option module with two Form-C relays can be added), EIA-485 port to interface with remote annunciators and optional remote relay modules plus a printer port.

The integral communicator transmits system status (alarms, troubles, AC loss, others) to UL-listed central stations via the public switched telephone network. The control panel has a built-in programmer. It also supervises all wiring, AC voltage, telephone line input voltage/current and battery level.

The control panel may be programmed or interrogated off site via the public switched telephone network. Any IBM compatible personal computer with Windows™ 3.1 or greater, with a 1200 baud Hayes™ compatible modem and Fire•Lite Upload/Download software P/N PK-5210UD, may serve as a Service Terminal. This allows downloading of any portion or all of the program and upload of any portion or all of the program, history file, walktest data, current status and system voltages. The MS-5210UDE offers the same features as the MS-5210UD but allows connection to 220/240 VAC input.

Note that unless otherwise specified, the term MS-5210UD shall be used in this manual to refer to both the MS-5210UD and the MS-5210UDE Fire Control Communicators.

1.1 Product Features

- Selectable as Local Fire Panel or Fire Panel/Communicator
- Programmable Zone ID: 2-Wire Smoke; Pull Station; Normally-Open Contact; Supervisory; Supervisory Auto-resettable; Waterflow (silenceable); Waterflow (nonsilenceable); Remote Switch for Reset, Silence, Acknowledge and Drill; Standard and Auto-reset Critical and Noncritical Process Monitoring
- 10 Style B (Class B) Initiating Device Circuits (IDCs)
- Two NFPA Style Y (Class B) Notification Appliance Circuits (NACs)
- CAC-10F Option Module to convert all 10 IDCs to Style D (Class A) and convert two Style Y (Class B) NACs to Style Z (Class A)
- 3.6 amps of system power expandable to 6.6 amps
- Remote Relay Option Module (ACM-8RF) providing one 5.0 amp relay per zone
- Built-in Programmer
- Built-in Voltmeter
- Telephone Line Active LED Indicators
- Communication Confirmation (Kissoff) LED
- Disable report by event
- Programmable Event Codes
- 24 Volt Operation
- Real Time Clock and Calendar
- Trouble Reminder
- Alarm Verification

Product Features

- Interfaces with Fire•Lite annunciators (requires LED-10IM Option Module)
 - LED-10 Series Remote Annunciator provides one red alarm and one yellow trouble LED per zone
 - LDM-32F Graphic Annunciator
 - ACS Series LED Annunciators
- Small Size 16.900" (42.9 cm) X 14.500" (36.8 cm) X 4.625" (11.8 cm)
- History File with 256 Event Storage
- Silence Inhibit per Notification Appliance Circuit
- Auto-Silence per Notification Appliance Circuit
- Touchtone/Rotary Dialing per telephone line
- Programmable Make/Break Ratio
- Fuseless Design
- Printer Interface Module (PRT-24)
- NAC-REM Option Module adds two Form-C relays and two Style Z (Class A) NACs
- Print Real-time System Status
- Print History, Walktest Files, Program Contents and Troubleshoot mode voltages
- PK-5210UD Upload/Download Software Kit
- Number of dial attempts (5 minimum, 10 maximum)
- Programmable Zone Delay (waterflow only)
- Low AC Voltage Sense
- One-man silent or audible Walktest
- Optional Dress Panel Coverplate (DP-5210UD)

FIGURE 1-1: Optional DP-5210UD

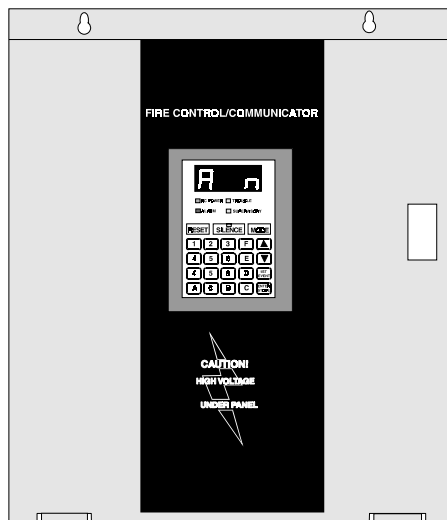
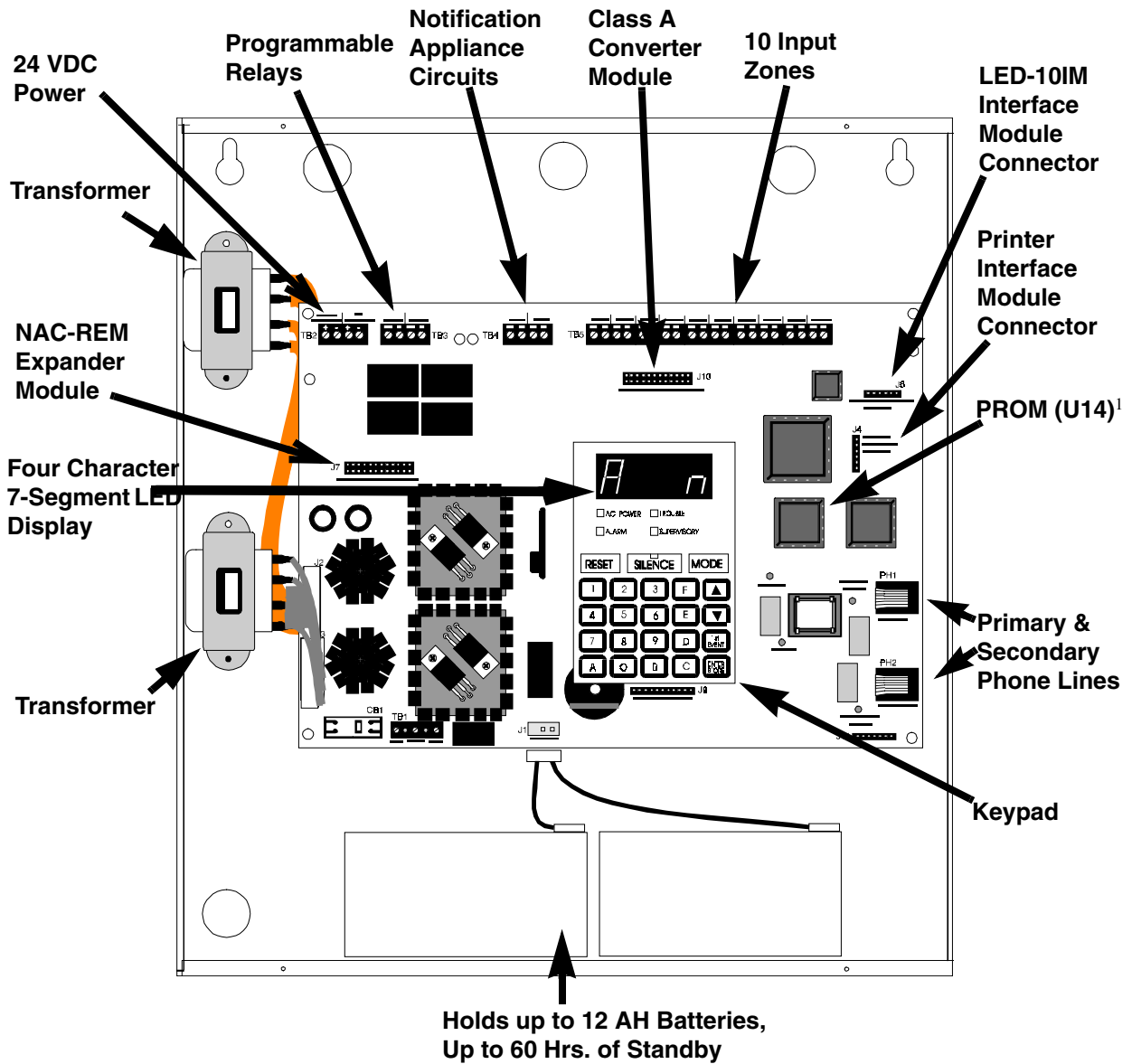

FIGURE 1-2: MS-5210UD Panel



¹Software for the Fire Control Communicator is located in a PROM inserted in the IC socket labeled U14. The MS-5210UD and MS-5210UDE each contain unique software. For specific panel software information, refer to the MS-5210UD/MS-5210UDE Field Software Change Procedure Document #50479.

1.2 Specifications

AC Power - TB1

MS-5210UD: 120 VAC, 60 Hz, 2.3 amps

MS-5210UDE: 220/240 VAC, 50 Hz, 1.2 amps

Wire size: minimum #14 AWG (2.0 mm²) with 600V insulation

Battery (lead acid only) - J1

Maximum Charging Circuit: Normal Flat Charge—27.6V @ 0.8 amp

Maximum Charger Capacity: 18 Amp Hour battery (MS-5210UD cabinet holds maximum 12 Amp Hour battery.

Larger batteries require Fire•Lite BB-17F or other UL listed battery cabinet)

Initiating Device Circuits TB5 and CAC-10F Option Module

Detector Zones 1 through 10

Power-limited Circuitry

Operation: All zones NFPA Style B - Convert to Style D using CAC-10F Class A Converter Module

Normal Operating Voltage: 24 VDC (ripple = 100 mV maximum)

Alarm Current: 15 mA

Short Circuit Current: 42 mA maximum

Maximum Loop Resistance: 100 ohms

End-of-Line Resistor: 4.7K, ½ watt (Part #27072 UL listed)

Detector Loop Current is sufficient to ensure operation of one alarmed detector per zone

Standby Current: 7.26 mA (includes ELR and 2 mA maximum detector current)

Smoke Detector Identifier A

Refer to Fire•Lite Device Compatibility Chart for listed compatible devices.

Notification Appliance Circuits - TB4 & NAC-REM Option Module (TB2 & TB3)

Nonregulated special purpose power, Styles Y & Z supported

Power-limited circuitry

Operating Voltage Nominal 24 volts

Current for all external devices: 3.0 amps expandable to 6.0 amps

Current Limit: TB4 via electronic protection, NAC-REM option module (TB2 & TB3) via PTC

Maximum signaling current/circuit: TB4 = 3.0 amps. NAC-REM = 1.5 amps.

End-of-Line resistor: 4.7K, ½ watt (Part #71252 UL listed) for Notification Appliance Circuits

Refer to Fire•Lite Device Compatibility Chart for listed compatible devices

Form-A Relays - TB3

TB3 contact rating: 2.0 amps @ 30 VDC (resistive), 5.0 amps @ 125 VAC (resistive)

NAC-REM Form-C contact rating: 2.0 amps @ 30 VDC, 0.6 amps @ 125 VAC (resistive)

Four-wire Smoke Detector Power - TB2 Terminals 3(+) & 4(-)

Maximum ripple voltage: 10 mV_{RMS} Operating Voltage nominal 24 volts

Up to 500 mA is available for powering 4-wire smoke detectors

Power-limited Circuitry. Recommended maximum Standby current is 50 mA¹

Refer to Fire•Lite Device Compatibility Chart for compatible listed devices

1. For power supply and battery calculations, refer to Appendix A.

Controls and Indicators

Nonresettable Regulated 24 VDC Power - TB2 Terminals 1(+) & 2(-)

Maximum ripple voltage: 10 mV_{RMS} Operating Voltage nominal 24 volts

Total DC current available from this output is up to 500 mA

Power-limited Circuitry. Recommended maximum Standby current is 150 mA¹

Refer to Fire•Lite Device Compatibility Chart for compatible listed devices

1.3 Controls and Indicators

Front Panel Switches

RESET
SILENCE
MODE
Up Arrow (ACK)
Down Arrow (ACK)
1st EVENT
ENTER/STORE
Digits 0 through 9
Letters A through F

Displays

Alarm - red LED
Trouble - yellow LED
Supervisory - yellow LED
AC Power - green LED
Four, Seven Segment Displays - red
Primary Phone Line Active - red LED
Secondary Phone Line Active - red LED
'Kissoff' Signal from Central Station - green LED
Silence - yellow LED
Modem - green LED

Local Sounder

A piezo sounder provides separate and distinct sounds for alarm, trouble, supervisory and critical process monitoring conditions

1.4 Circuits

Input Circuits

Ten input circuits provide Style B (Class B) configuration standard and may be converted to Style D (Class A) by installing the CAC-10F module. Input circuits may be used as standard fire control panel zones, remote input switches (Acknowledge, Silence, Drill, Reset) or as standard or auto-resettable critical and noncritical process monitoring. All ten Initiating Device Circuits accept Normally-Open contact devices and two-wire smoke detectors.

FIGURE 1-3: Display and Keypad



1. Total current for nonresettable power, four-wire smoke power, and four Notification Appliance Circuits *must not exceed 6.0 amps*. Total system current in excess of 3.6 amps requires the XRM-24 Transformer (XRM-24E for 220/240 VAC applications) and 12 Amp Hour or 18 Amp Hour batteries.

Digital Communicator

Output Circuits

- 24 Volt Resettable Power Output 500 mA
- 24 Volt Nonresettable Power Output 500 mA
- Primary Telephone Line
- Secondary Telephone Line
- 24 Volt Battery Charger (up to 18 AH batteries)
- Printer Port
- EIA-485 Port (interfaces to LED-10 Annunciator, AFM Series and LDM Graphic Series Annunciators and ACM-8RF Remote Relay Module)

Notification Appliance Circuits

Two Notification Appliance Circuits Style Y (Class B) configurable for Style Z (Class A) using the CAC-10F option module.

Relays

Two dry Form-A relay contacts programmable for system alarm, system trouble, system supervisory (standard and autoresettable), standard and autoresettable process monitoring or communications failure are provided. Contacts are rated 2.0 amps @ 30 VDC (resistive). Two additional Form-C relay contacts programmable for alarm, trouble, standard and autoresettable supervisory, standard and autoresettable process monitoring or communications fail are available using the NAC-REM (NAC/Relay) option module. Contacts are rated 2.0 amps @ 30 VDC and 0.6 amps at 125 VAC (resistive).

Printer Port

EIA-232 compatible, fully supervised and programmable for 2400, 4800 and 9600 Baud. Only one printer may be connected to the port. Consult the factory for recommended printers.

EIA-485 Port

EIA-485 compatible port on the LED-10IM option module supports up to 32 LED-10 Remote Annunciators or 32 sets of ACM-8RF Relay Modules or 32 AFM Series Annunciators or 32 LDM Series Annunciators or any combination of the four devices totalling 32.

Telephone Lines

Fully supervised at all times, voltage is sensed to 4 volts and current is sensed to 5 mA.

Battery Charger

Battery Charger will charge up to 18 AH batteries. The MS-5210UD cabinet holds a maximum of 12 AH batteries. The Fire•Lite BB-17F is required to hold 18 AH batteries. The charger is rated for 850 mA maximum current.

1.5 Digital Communicator

Two modular phone jacks allow easy connection to telephone lines. Modular jacks are labeled PH1 and PH2 for the Primary and Secondary phone lines. Telephone line 'Active' red LEDs are provided as well as a green 'Kissoff' LED. The integral digital communicator provides the following functions:

- Line Seizure - takes control of the phone lines disconnecting any premises phones
- Off/On Hook - perform on and off-hook status to the phone network
- Listen for dial tone - 440 hertz tone typical in most networks
- Dialing the Central Station(s) number - default is Touch-Tone[®], programmable to rotary
- For tone burst or touchtone type formats: discern proper 'Ack' and 'Kissoff' tone(s) - the frequency and time duration of the tone(s) varies with the transmission format. The control panel will adjust accordingly

Components

- Communicate in the following formats:
 - ✓ 12 Tone Burst Type: 20 pps
(3+1, 4+1, 4+2, 3+1 Exp., 4+1 Exp., 4+2 Exp.)
 - ✓ 3 Touchtone Types:
 - 4 + 1 Ademco Express
 - 4 + 2 Ademco Express
 - Ademco Contact ID (Refer to Table 4-3 on page 78).

1.6 Components

Main Circuit Board

The main circuit board contains the system's CPU, power supply, other primary components and wiring interface connectors. Optional modules plug in and are mounted to the main circuit board. The main circuit board is delivered pre-mounted in the cabinet.

Cabinet

The cabinet is red with an attractive navy blue front overlay. The backbox measures 16.900" (42.9 cm) X 14.500" (36.8 cm) X 4.625"(11.8 cm) and provides space for two batteries (up to 12 Amp Hours). Also available is an optional dress panel, DP-5210UD, which mounts inside the cabinet.



Transformer Assembly

One 100VA transformer is provided standard with the panel. An optional 100VA transformer, XRM-24 (XRM-24E for the MS-5210UDE), is available to provide maximum accessory power.

Batteries

The cabinet provides space for 12 Amp Hour batteries (larger batteries up to 18 Amp Hour batteries, use the listed Fire•Lite BB-17F battery box). Batteries must be ordered separately

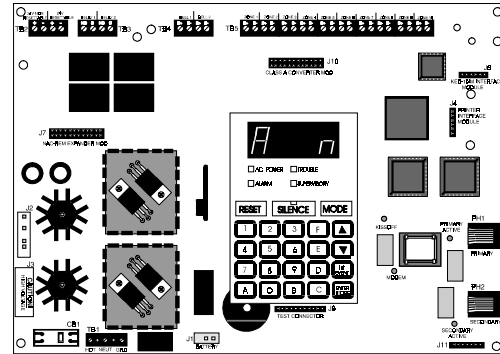
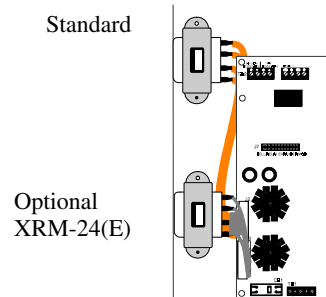

FIGURE 1-4: Transformer Assemblies



1.7 Optional Modules

LED-10IM

The LED-10IM Interface Module provides an EIA-485 port to support the LED-10 Series Remote Annunciator, LDM Series Annunciator, ACS Series Annunciator and ACM-8RF Relay Modules. EIA-485 wiring is supervised for open circuits by this module. The LED-10IM mounts to connector J6 in the upper right corner of the main board. Refer to Figure 2-14, “LED-10IM Installation,” on page 35.

ACM-8RF Relay Module

The ACM-8RF option module provides eight Form-C relays rated a 5.0 amps each. The Relay Module connects to the EIA-485 port off of the LED-10IM option module. Relays are assigned to each of the 10 Initiating Device Circuits. Refer to Figure 2-17, “Wiring LED-10IM to ACM-8RF,” on page 36, for additional information.

PRT-24 Printer Interface Module

The Printer Interface Module may be used to connect a printer to the control panel for the purpose of printing a history report, walktest file, troubleshoot report, program entries or current system status. Printers require separate external primary power. Connect the PRT-24 module (with cable) to the serial EIA-232 port on the printer. The module mounts to the J4 connector on the main circuit board.

Note that an EDP listed printer must be used if printer will be permanently attached (Refer to Figure 2-13, “Remote Printer Connections,” on page 34). The Baud rate is programmable (“Program Options” on page 40).

CAC-10F Module

The CAC-10F Module can be used to convert the 10 Style B (Class B) Initiating Device Circuits to 10 Style D (Class A) IDCs and the two Style Y (Class B) Notification Appliance Circuits to two Style Z (Class A) NACs. The CAC-10F module connects to J10 on the main circuit board. (Refer to Figure 2-10 on page 32).

NAC-REM Module

The NAC-REM (NAC/Relay) Module can be used to add two Style Z (Class A) NACs and two Form-C relays. The module connects to J7 on the main circuit board. (Refer to Figure 2-12 on page 33).

1.8 Optional Accessories

Dress Panel

A red dead-front dress panel (DP-5210UD) is available as an option. The dress panel restricts access to the system wiring while allowing access to the membrane switch panel.

Battery Box

The Fire•Lite BB-17F battery box may be used to house two batteries greater than 12 Amp Hour to a maximum of 18 Amp Hour. The battery box mounts directly below the cabinet, centered to the main circuit board (Refer to Figure 2-2, “FACP Backbox and Battery Box,” on page 25). The BB-17F is red and is provided with knockouts.

FIGURE 1-5: BB-17F Battery Box

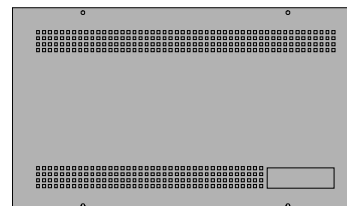

PK-5210UD Program Kit

The PK-5210UD Program Kit includes three 3½" diskettes plus Instruction Manual P/N 50363. When the software is loaded into an IBM compatible computer, it creates an off-line Service Terminal that allows any MS-5210UD panel to be uploaded or downloaded over standard telephone lines. Requires panel firmware P/N: MS52102.0 or greater.

Optional Accessories

LED-10 Series Annunciator (LED Zone Type Annunciator)

The LED-10 Series is a 10 zone LED annunciator which mounts on a 3-gang electrical box and provides LED indication of the following:

- Alarm Zones 1 through 10
- Trouble Zones 1 through 10
- AC Power (green)
- System Alarm (red)
- System Trouble (yellow)
- System Supervisory (yellow)
- Alarm Silence (yellow)

A local trouble sounder and switches for remote Acknowledge, Silence, Drill and Reset are also provided. Wiring is inherently supervised by the FACP. Slide-in paper labels permit an easy change of zone information. DIP switches allow the enabling and disabling of the local piezo sounder (with approval of local AHJ), enabling and disabling of the mechanical keyswitch which may be used to prevent unauthorized use of the function switches and selection of annunciator receive/transmit mode (Refer to Figure 2-15 on page 35).

Note that the LED-10 Series Remote Annunciator requires the use of the LED-10IM Interface Module.

FIGURE 1-6: LED-10 Series Annunciator

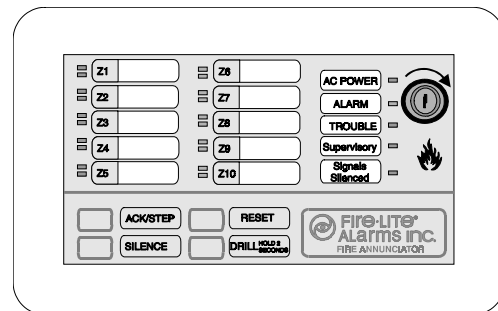

ACS Series Annunciators (LED Zone Type)

The ACS Series Annunciators remotely display system status. The annunciators display zone alarm and trouble status. In addition, they provide remote Acknowledge, Silence, Reset and Drill functions. The ACS Series Annunciators require the use of the LED-10IM Interface Module. For more detailed information, refer to the appropriate annunciator manual.

- ✓ **ACM-16ATF** - The Annunciator Control Module-16ATF contains 16 red alarm and 16 yellow trouble LEDs, a system trouble LED, an ON LINE/POWER LED and a local piezo sounder with switches for Acknowledge, Silence, Reset and Drill. The ACM-16ATF has rotary address switches and will accept up to 3 AEM-16ATF Expanders. The ACM-16ATF can be mounted in a Fire•Lite ABS-1F or ABF-1F backbox. Refer to the ACM-16ATF Manual for detailed information. *Note that only one ACM-16ATF is required to annunciate 10 zones of alarm and trouble, provided '8 Point Shift' function is selected. Refer to Annunciator Manual P/N 51480 for additional information.*
- ✓ **AEM-16ATF** - The Annunciator Expander Module-16ATF connects to the ACM-16ATF and adds 16 sets of red alarm LEDs and yellow trouble LEDs. Up to three AEM-16ATFs may be added to an ACM-16ATF but only one is required. *Note that one AEM-16ATF is required with an ACM-16ATF to annunciate 10 zones of alarm and trouble as well as general system status provided '8 Point Shift' function is not selected. Refer to Annunciator Manual P/N 51480 for additional information.*

FIGURE 1-7: ACM-16ATF

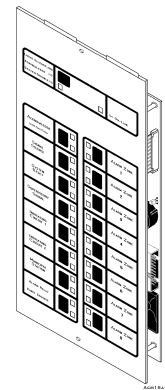

Optional Accessories

- ✓ **AFM-16ATF** - The Annunciator Fixed Module-16ATF contains 16 red alarm and 16 yellow trouble LEDs, a system trouble LED, an ON LINE/POWER LED and a local piezo sounder with switches for Acknowledge, Silence, Reset and Drill. The AFM-16ATF is fixed at address '1' and communication is via the EIA-485 data line. The AFM-16ATF can be mounted in a Fire•Lite ABS-1F or ABF-1F backbox. Refer to the AFM-16AT Manual for detailed information.
- ✓ **AFM-16AF** - The Annunciator Fixed Module-16AF has 16 red alarm LEDs. Multiple annunciators may be used by setting all annunciators to Receive Only, except the last AFM-16AF in line. Each annunciator's address is internally fixed at '1' and communication is via the EIA-485 data line. The Local Silence/Acknowledge switch functions as local lamp test and silence for annunciator piezo. LEDs include On-Line and System Trouble indicators. The AFM-16AF Annunciator can be mounted in a standard 4-gang electrical box. Refer to the AFM-16AF Manual for detailed information.

FIGURE 1-8: AFM-16ATF

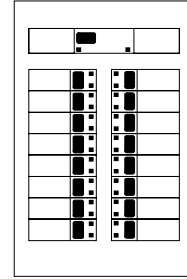
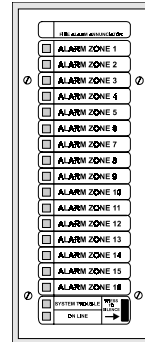

FIGURE 1-9: AFM-16AF



LDM Series Lamp Driver Modules (Graphic Annunciator)

The LDM Series Lamp Driver Modules, which consist of the LDM-32F master and LDM-E32F expander modules, are used to provide an interface to a custom graphic LED annunciator. The master module provides power and control for a maximum of three expander modules (expander modules are not required when interfacing to the MS-5210UD). The LDM-32F and LDM-E32F have output connectors which are used to drive lamps or LEDs and input connectors which are used for remote switch functions. The LDM Series requires the use of the LED-10IM Interface Module. Refer to the LDM Series Lamp Driver Modules Manual for a complete description. Refer to Figure 2-18, "Wiring LED-10IM to LDM-32F," on page 37 for wiring details.

- ✓ **LDM-32F** - The Lamp Driver Module has 32 alarm lamp/LED driver outputs which sink current to system common (-) on activation. A single positive (+) voltage is required to supply total operating power for all lamps or LEDs when all drivers are activated. The LDM-32F provides a separate driver for system trouble and inputs for a local lamp test switch. A maximum of 16 external control switches may be wired to the LDM-32F. DIP switch SW3 is used to enable or disable the onboard piezo sounder, enable remote switch functions, select a flashing LED function for new alarms and troubles and other functions. Switch SW4 is used to configure the module to annunciate 32 alarms or 16 alarms and 16 troubles. A green ON-LINE LED flashes to indicate ongoing communications with the host FACP. One LDM-32F supports up to three LDM-E32F modules. The LDM-32F is supplied with four standoffs and screws for mounting to a CHS-4L chassis or custom backbox.

FIGURE 1-10: LDM-32F Module

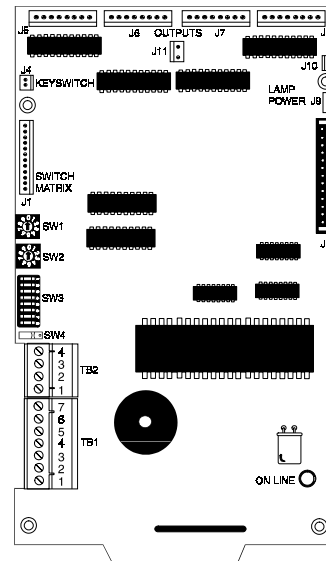

FCPS-24F(E) Remote Power Supply (System Power Expansion)

The FCPS-24F (FCPS-24FE for 220/240 VAC applications) is a compact, remote power supply and battery charger. This remote power supply consists of a filtered 24 VDC output that may be configured to drive up to four Notification Appliance Circuits [four Style Y (Class B) or two Style Z (Class A) and two Style Y (Class B)]. Alternately, the four Notification Appliance Circuits may be used as auxiliary regulated power configured for resettable or nonresettable operation.

The FCPS-24F(E) may be used in a number of different applications. It may be used as a remotely mounted power supply and battery charger powering up to four, coded or noncoded, Notification Appliance Circuits. Alternately, any or all of these circuits may be used as 24 VDC output circuits capable of powering four-wire smoke detectors or any device that requires filtered power. These circuits may be configured as resettable or nonresettable outputs to expand FACP auxiliary system power.

FIGURE 1-11:FCPS-24F(E)

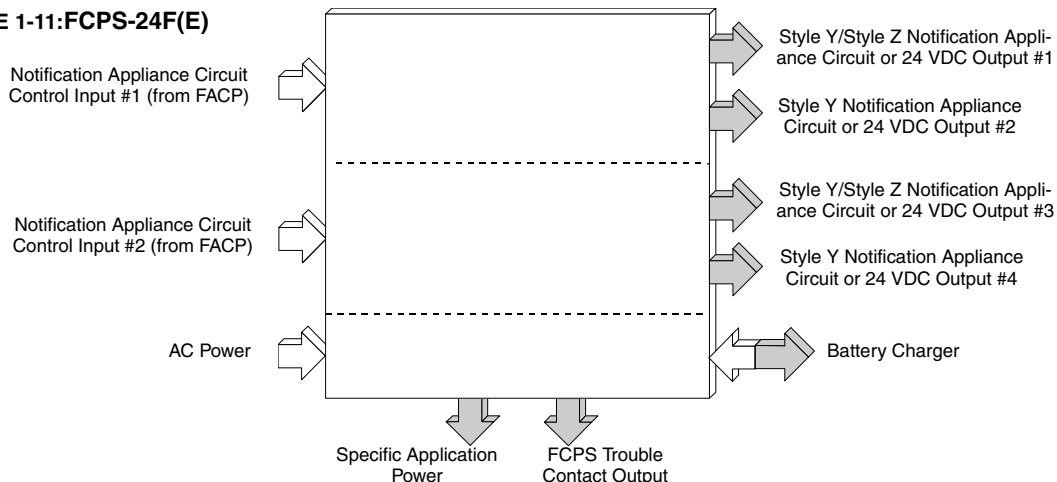

One of the most common applications for the FCPS-24F(E) remote power supply utilizes the NAC expander mode. In this application, one or two Notification Appliance Circuits (NACs) are connected from the main FACP NAC output(s) to the remote power supply Control Input circuits. When these Control Input circuits activate (due to reverse polarity of the NAC output), the power supply will activate its corresponding outputs. NAC Control Input #1 controls power supply output circuits #1 and #2. NAC Control Input #2 controls output circuits #3 and #4.

During the inactive state, the remote power supply supervises its NAC field wiring for short and open circuits. If a fault is detected, the supply will enter a trouble condition and illuminate the corresponding NAC trouble LED (Output Circuits 1-4), however, once the Notification Appliance Circuits are activated, the supervision is disabled and the circuits are no longer supervised. Supervision of other power supply faults such as low battery, Earth Fault, AC loss and battery charger failure will continue and may be monitored via the independent trouble relay contact.

If a specific application requires that all four outputs activate at the same time, only one NAC control input from the FACP is necessary. For this application, The Notification Appliance Circuit from the FACP is wired into NAC Control Input #1 of the remote supply and then a pair of wires are connected from NAC Control Output #1 to NAC Control Input #2. Refer to the FCPS-24F(E) Installation, Operation and Application Manual for a complete description and examples of applications.

1.9 Telephone Requirements and Warnings

1.9.1 Telephone Circuitry:

- Ringer Equivalence Number (REN) = 0.6B
- Complies with FCC Part 68
- Mates with RJ31X Male Connector
- Supervision Threshold: less than 4.0 volts for 2 minutes

The REN is used to determine the quantity of devices which may be connected to the telephone line. Excessive RENs on the telephone line may result in the devices not ringing in response to an incoming call. In most, but not all areas, the sum of the RENs should not exceed five (5.0). To be certain of the number of devices that may be connected to the line, as determined by the total RENs, contact the telephone company to determine the maximum REN for the calling area.

1.9.2 Digital Communicator:

Before connecting the control panel to the public switched telephone network, the installation of two RJ31X jacks is necessary. The following information is provided if required by the local telephone company:

- Manufacturer: Fire•Lite
 - One Fire-Lite Place
 - Northford, CT 06472
- Product Model Number: MS-5210UD
- FCC Registration Number: 1W6USA-74525-AL-E
- Ringer Equivalence: 0.6B

Note: The FCC ID label is located on the inside of the FACP door.

1.9.3 Telephone Company Rights and Warnings:

The telephone company, under certain circumstances, may temporarily discontinue services and/or make changes in its facilities, services, equipment or procedures which may affect the operation of this control panel. The telephone company, however, is required to give advance notice of such changes or interruptions.

If the control panel causes harm to the telephone network, the telephone company reserves the right to temporarily discontinue service. Advance notification will be provided, except in cases when advance notice is not practical. In such cases, notification will be provided as soon as possible. The opportunity will be given to correct any problems and to file a complaint.

DO NOT CONNECT THIS PRODUCT TO COIN TELEPHONE, GROUND START OR PARTY LINE SERVICES.

When the control panel activates, premise phones will be disconnected.

Two separate phone lines are required. Do not connect both telephone interfaces to the same telephone line.

The control panel must be connected to the public switched telephone network upstream of any private telephone system at the protected premises.

An FCC compliant telephone cord must be used with this equipment. This equipment is designed to be connected to the telephone network or premises wiring using a compatible RJ31X male modular plug which is Part 68 compliant.

CHAPTER 2 *Installation*

2.1 Mounting Options

The cabinet may be either semi-flush or surface mounted. The door is removable during the installation period by opening and lifting the door off the pin hinges. The cabinet mounts using two key slots and two additional 0.250" (6.35 mm) diameter holes located in the backbox. The key slots are located at the top of the backbox and the two securing holes at the bottom.

Carefully unpack the system and check for shipping damage. Mount the cabinet in a clean, dry, vibration-free area where extreme temperatures are not encountered. The area should be readily accessible with sufficient room to easily install and maintain the panel. Locate the top of the cabinet approximately five feet above the floor with the hinge mounting on the left. Determine the number of conductors required for the devices to be installed. Sufficient knockouts are provided for wiring convenience. Select the appropriate knockout(s) and pull the required conductors into the box. Note that there are no knockouts on the left (hinged) side of the cabinet. All wiring should be in accordance with the National and/or Local codes for fire alarm systems.



2.2 Backbox Mounting

- ✓ Open the door and lift the door off the pin hinges.
- ✓ Remove the main PC board assembly by unscrewing the four screws in the corners of the board. Set the board aside in a safe, clean place. Avoid static discharge which may damage the board.
- ✓ Mark and predrill holes for the top two keyhole mounting bolts using the dimensions illustrated in Figure 2-1.
- ✓ Install two upper fasteners in the wall with the screw heads protruding.
- ✓ Using the upper 'keyholes', mount the backbox over the two screws.
- ✓ Mark and drill the lower two holes.
- ✓ Mount backbox, install remaining fasteners and tighten.
- ✓ When the location is dry and free of construction dust, reinstall the main PC board.

Backbox Mounting

Draw wires through the respective knockout locations.

FIGURE 2-1: Cabinet Dimensions and Knockout Locations

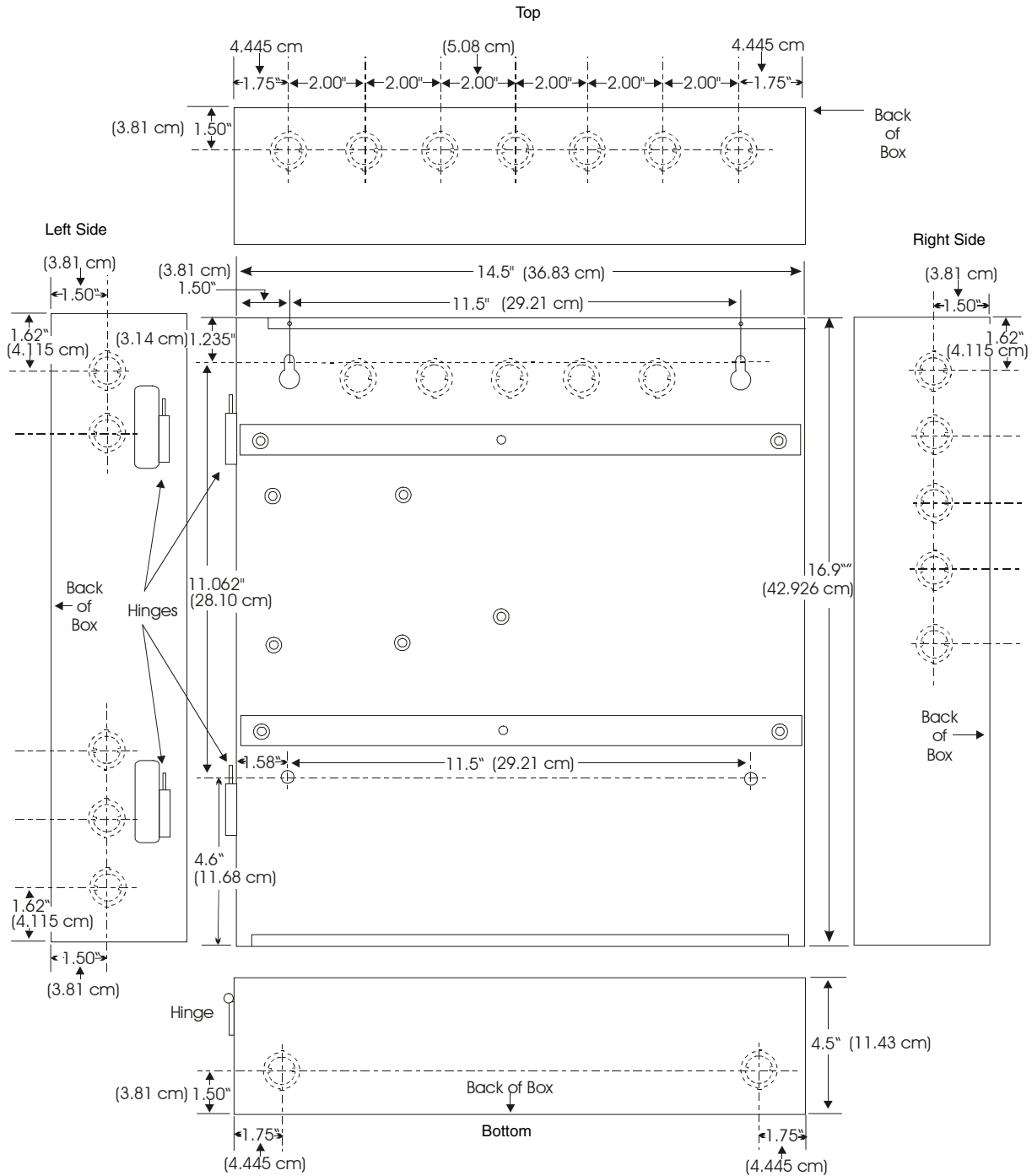

Backbox Mounting

FIGURE 2-2: FACP Backbox and Battery Box

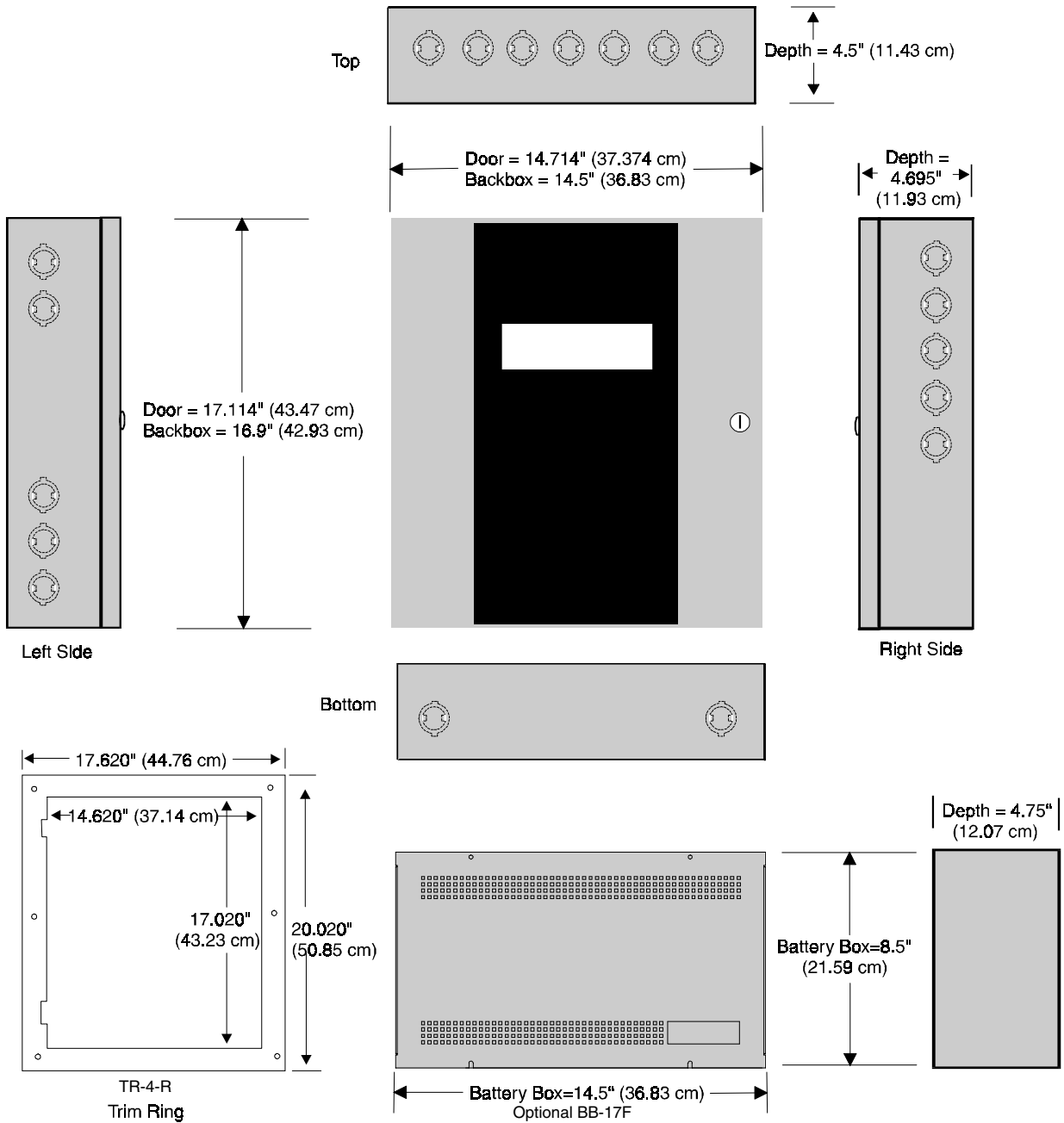

When batteries larger than 12 Amp Hour are being used, the BB-17F battery box (or equivalent) must be installed. To install the BB-17F:

1. Mount the FACP cabinet to the wall.
2. Remove knockouts on the bottom of the FACP cabinet and top of the BB-17F.
3. Using conduit, hang the BB-17F from the FACP cabinet making sure there is at least ½" of clearance between the two cabinets.
4. Anchor the BB-17F to the wall.

2.3 Operating Power

! WARNING: Several different sources of power can be connected to this panel. Disconnect all sources of power before servicing. The panel and associated equipment may be damaged by removing and/or inserting cards, modules or interconnecting cables while this unit is energized.

Primary Power Source (AC) and Earth Ground Connections

AC power connections are made inside the control panel cabinet. The primary power source for the MS-5210UD is 120 VAC, 60 Hz, 2.3 amps and for the MS-5210UDE is 220/240 VAC, 50 Hz, 1.2 amps. Run a pair of wires (with ground conductor) from the protected premises main breaker box to TB1 of the main circuit board. As per the National Electric Code, use 14 AWG (2.00 mm², 1.6 mm O.D.) or heavier gauge wire with 600V insulation. No other equipment may be connected to this circuit. In addition, this circuit must be provided with overcurrent protection and may not contain any power disconnect devices. A separate Earth Ground connection must be made to ensure proper panel operation and lightning and transient protection. Connect the Earth Ground wire [minimum 14 AWG (2.00 mm²)] to one of the transformer mounting studs. *Do not use conduit for the Earth Ground connection since this does not provide reliable protection.*

Secondary Power Source (Batteries)

Observe polarity when connecting the battery. Connect the battery cable to J1 on the main circuit board using the plug-in connector and cable provided. The battery charger is current-limited and capable of recharging sealed lead acid type batteries. The charger shuts off when the system is in alarm or if the battery voltage drops too low (below 17.4 VDC). See “Battery Calculations” on page 91 for calculation of the correct battery rating.

! WARNING: Battery contains sulfuric acid which can cause severe burns to the skin and eyes and can destroy fabrics. If contact is made with sulfuric acid, immediately flush the skin or eyes with water for 15 minutes and seek immediate medical attention.

FIGURE 2-3: Operating Power Connections

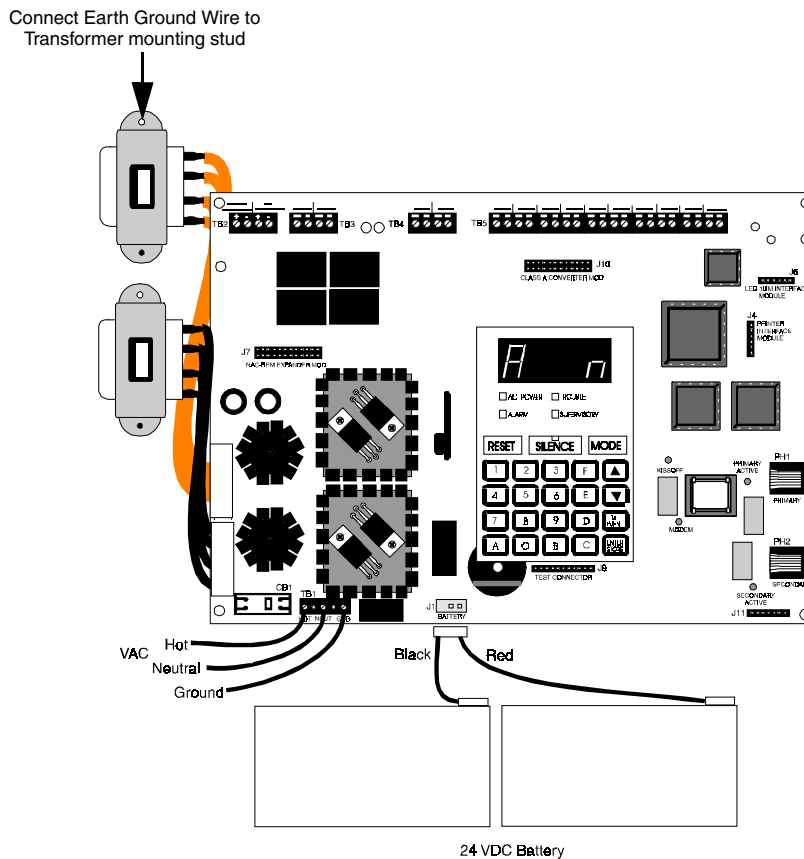

2.4 Input Circuits

The control panel has 10 zone input circuits. The maximum loop resistance limit for each input circuit is 100 ohms. All field wiring of each zone is supervised for opens and ground faults. Both conditions are visually and audibly annunciated as well as communicated to a central station.

Each zone is a Style B (Class B) Initiating Device Circuit (IDC) designed to accept any Normally-Open contact device and conventional 2-wire, 24 volt smoke detectors. Refer to Figure 2-4, "Style B Initiating Device Circuit Connections," on page 28, for information on wiring Style B circuits. Use the CAC-10F Option Module (Refer to Figure 2-11, "Wiring NACs and IDCs for Class A Operation," on page 32) to convert all 10 circuits to Style D (Class A). Each zone is power-limited to 7.26 mA in standby and 42 mA in alarm.

The zones may be programmed as shown below. The factory default is 2-wire smoke detector for all zones:

- 2-wire Smoke Detector (factory default)
- Pull Station
- Normally-Open Contact Device(s)
- Supervisory
- Supervisory, auto-resettable
- Waterflow, silenceable
- Waterflow, nonsilenceable
- Reset
- Silence
- Drill
- Acknowledge
- Auto-resettable critical and noncritical process monitoring
- Critical and noncritical process monitoring

A maximum of five waterflow devices may be used on any circuit programmed as a waterflow zone per NFPA 72.

Four-wire smoke detectors may be connected to any zone. Resettable power is provided via TB2 Terminals 3 and 4. Refer to the Fire•Lite Device Compatibility Document for a list of compatible smoke detectors.

It is allowable to mix an assortment of device types (i.e. smoke detectors, heat detectors, pull stations, etc.) on any zone. This is not recommended, however, since specific and detailed reports will not be possible (particularly critical when using Contact ID format). For example, the report of general fire alarm versus pull station fire alarm or smoke detector fire alarm could not be distinguished.

Note that Process Monitoring refers to circuits which do not specifically tie into elements of the fire system as defined by NFPA codes. With the exception of burglary functions, process monitoring circuits could be used to monitor any nonfire functions such as water temperature, room temperature, door open/closed, gas leakage, chemical leakage, etc.

Process Monitoring may be accomplished for Local, Remote and Central Station type services in the following ways:

- **Central and Remote Station** - When a critical process is detected, the DACT will transmit the critical process alarm to the Central or Remote Station.
- **Local** - When a critical process is detected, the relays (fail-safe) programmed to transfer will deenergize. The ACM-8RF Remote Relay Module can only be used with noncritical process monitoring.

FIGURE 2-4: Style B Initiating Device Circuit Connections

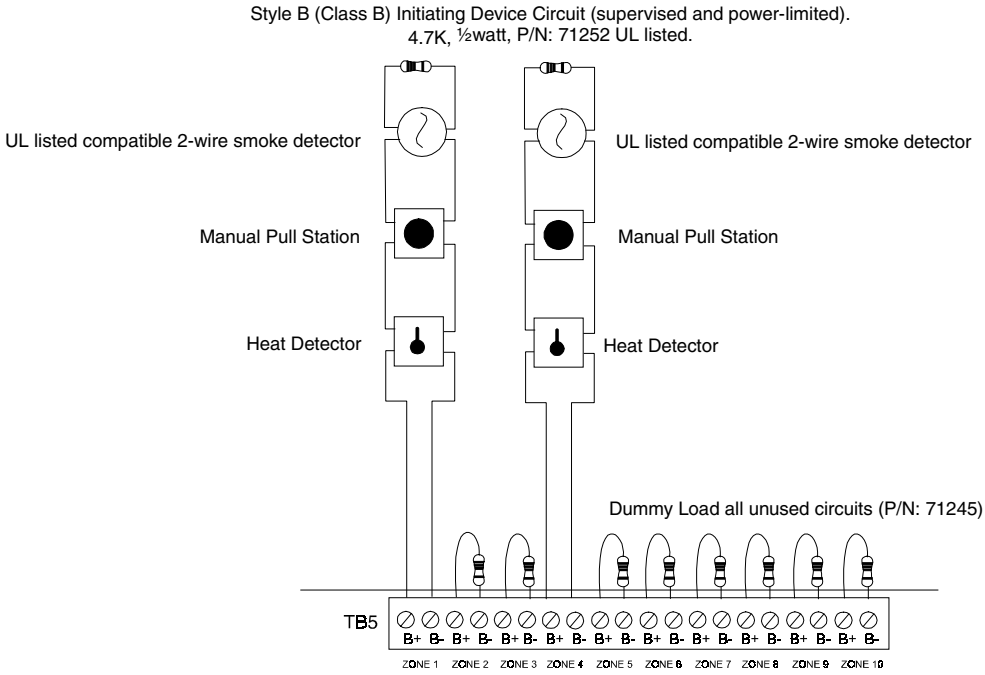

2.5 Output Circuits

DC Power Output Connections

All DC power outputs are power-limited.

FIGURE 2-5: Auxiliary Power Connections

Nonresettable Power (500 mA)
24 VDC filtered, regulated, nonre-settable power can be obtained from TB2 Terminals 1(+) and 2(-).

4-Wire Smoke Detector Power (500 mA)
24 VDC filtered, regulated, resettable power for 4-wire smoke detectors can be obtained from TB2 Terminals 3(+) and 4(-).

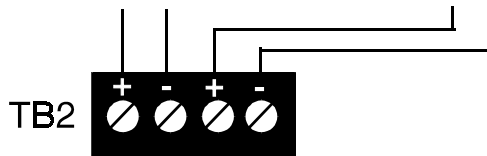

Telephone Circuits

Provision to connect to two independent telephone lines is available via two telephone jacks labeled PH1 (Primary) and PH2 (Secondary). Telephone line control/command is possible via double line seizure as well as usage of an RJ31X style interconnection. Refer to Figure 2-8, “Wiring Phone Jacks,” on page 30.

Output Circuits

Notification Appliance Circuits

The MS-5210UD provides two Notification Appliance Circuits standard as Style Y (Class B). Each circuit is capable of 3.0 amps of current. Total current drawn from these as well as other DC power outputs cannot exceed 3.6 amps with the standard transformer, 6.0 amps if an optional XRM-24 Transformer (XRM-24E for the MS-5210UDE) is installed. Circuits are supervised and power-limited. Refer to the Fire•Lite Device Compatibility Document for a listing of compatible notification appliances.

All Notification Appliance Circuits may be programmed as follows:

- Silenceable
- Enabled/Disabled
- Auto Silence, 5 to 30 minutes
- Nonsilenceable
- Silence Inhibited
- March Time, Temporal or California rates.

FIGURE 2-6: Notification Appliance Circuit Connections

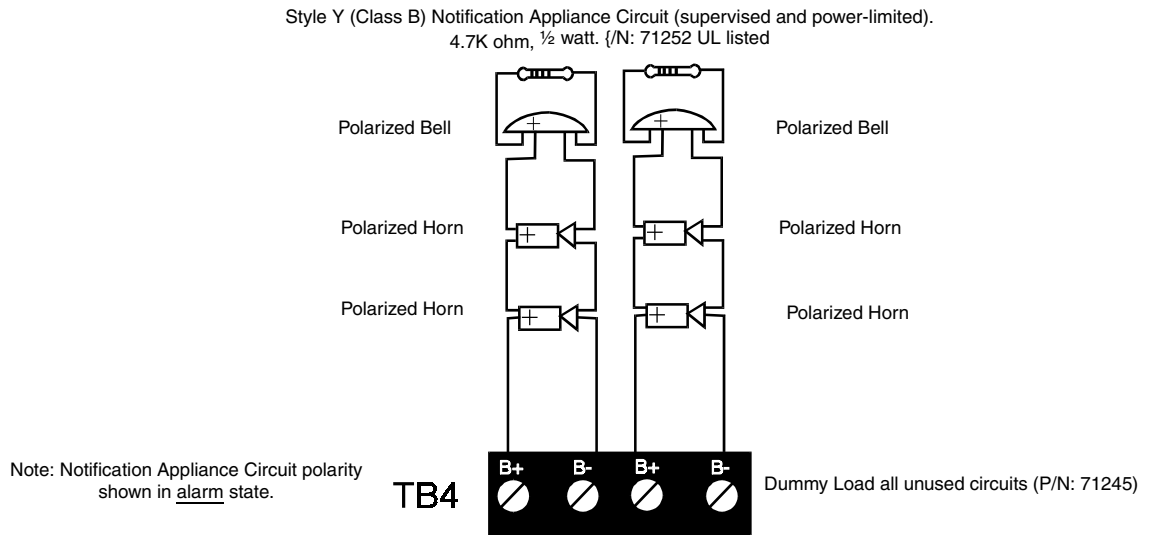

Standard Relays

The control panel provides two Form-A relays rated for 2.0 amps @ 30 VDC (resistive). Two Form-C relays can be added by installing the optional NAC-REM (NAC/Relay) module.

FIGURE 2-7: Programmable Relay Terminals

Relay connections may be power-limited or nonpower-limited, provided that a minimum of 0.25" is maintained between conductors of power-limited and nonpower-limited circuits.

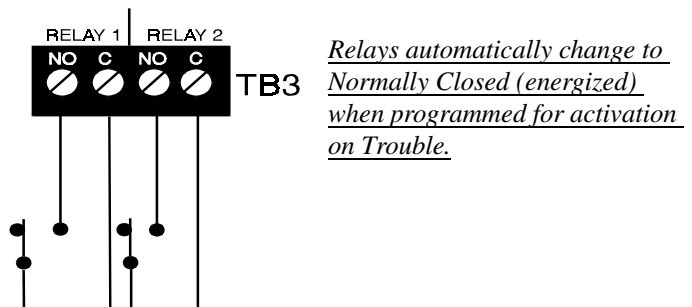

2.6 Digital Communicator

Two independent telephone lines can be connected to the control panel. Telephone line control/command is made possible via double line seizure as well as usage of an RJ31X style interconnection. It is critical that the panel's digital communicator be located as the first device on the incoming telephone circuit to properly function.

The control panel's digital communicator is built into the main circuit board. Connection and wiring of two phone lines is required as shown in Figure 2-8.

FIGURE 2-8: Wiring Phone Jacks

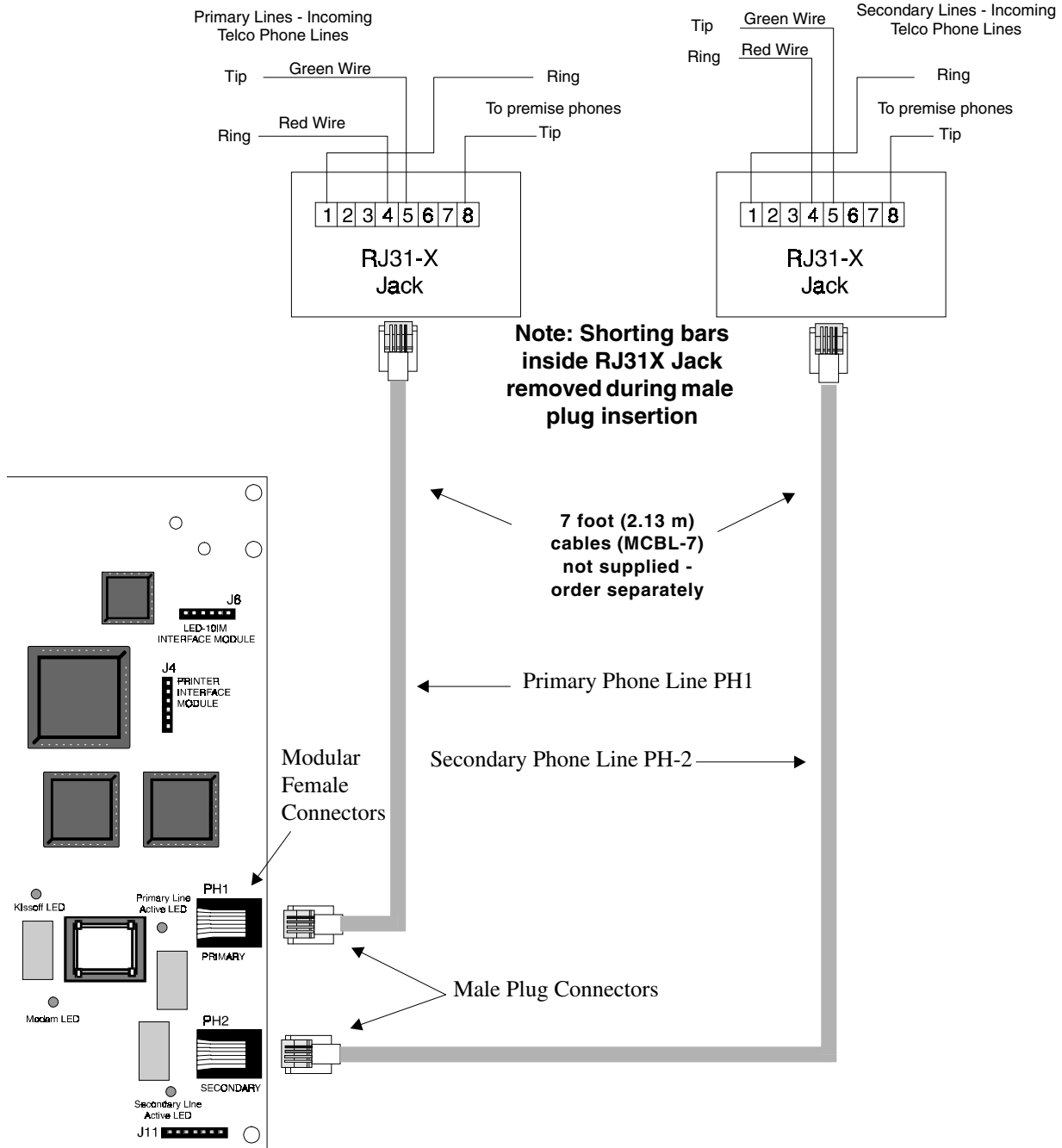

2.7 UL Power-limited Wiring Requirements

Power-limited and nonpower-limited circuit wiring must remain separated in the cabinet. All power-limited circuit wiring must remain at least 0.25" (6.35 mm) away from any nonpower-limited circuit wiring. Furthermore, all power-limited and nonpower-limited circuit wiring must enter and exit the cabinet through different knockouts and/or conduits. A typical wiring diagram for the MS-5210UD is illustrated in Figure 2-9.

FIGURE 2-9: Typical Wiring Diagram for UL Power-limited Requirements

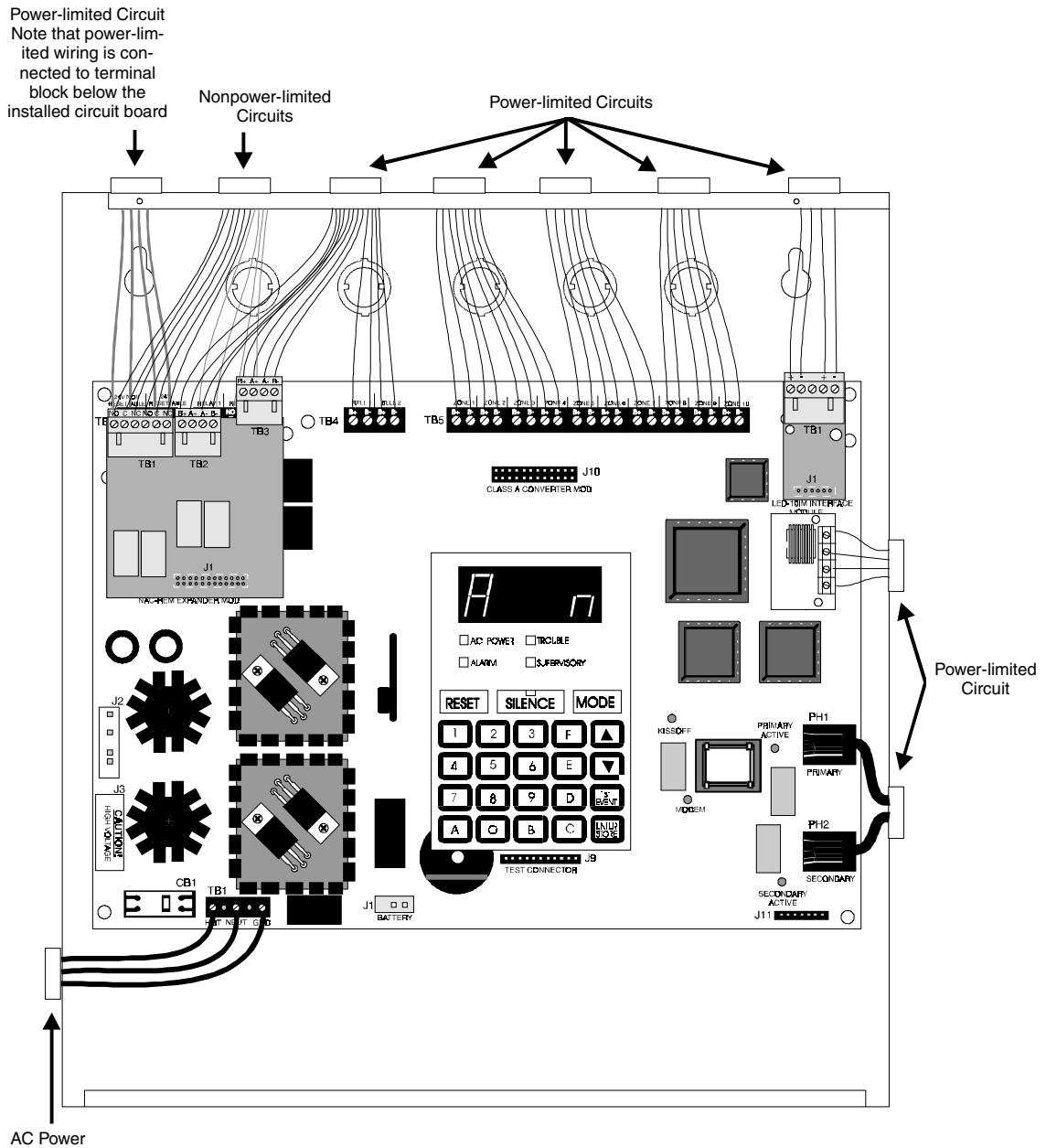

2.8 Installation of Optional Modules

CAC-10F Class A Converter Module

The CAC-10F Module can be used to convert the 10 Style B (Class B) Initiating Device Circuits to 10 Style D (Class A) IDCs and the two Style Y (Class B) Notification Appliance Circuits to two Style Z (Class A) NACs. J1 of the module plugs into connector J10 of the MS-5210UD, which is located at the top center of the FACP main circuit board.

Install the two supplied metal standoffs in the holes on the main circuit board (refer to Figure 2-10). Carefully align the two connectors and press the CAC-10F module securely into place. Make certain the pins are properly aligned to prevent bending or breaking of any pins. Secure the CAC-10F module to the standoffs using the two supplied screws. It is important that the supplied screw and washer be used to secure the module to the metal standoff. This is necessary in order to help protect against electrical transients.

FIGURE 2-10: Installation of CAC-10F Module

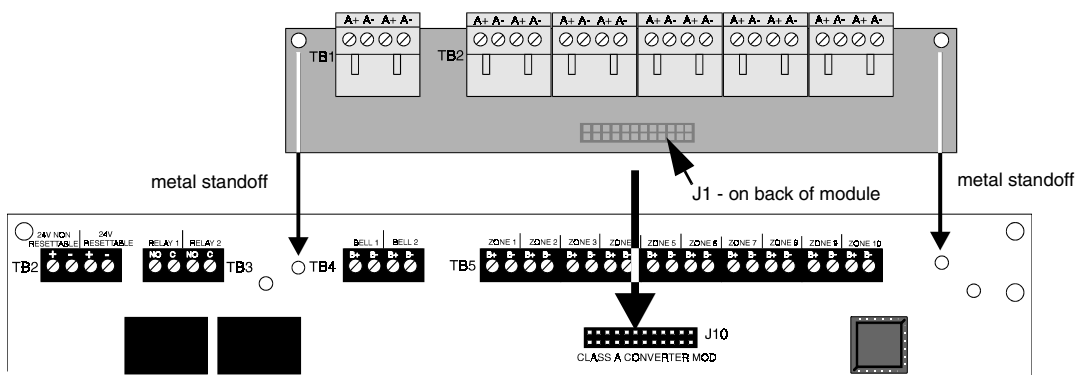

Wire the Style Z (Class A) Notification Appliance Circuits (NACs) using TB4 of the MS-5210UD and TB1 of the CAC-10F module. Wire the Style D (Class A) Initiating Device Circuits (IDCs) using TB5 of the MS-5210UD and TB2 of the CAC-10F module. Make certain to observe polarity when connecting the devices to the circuits. The B+ and A+ terminals must comprise the feed and return for the positive side of a device and the B- and A- terminals must comprise the feed and return for the negative side of a device. To configure any of the zones for Class B when the CAC-10F is installed, simply wire to the B+ and B- inputs on TB5 of the main circuit board and install the EOL resistor across the end of the circuit. Do not wire to the corresponding A+ and A- terminals on TB2 of the CAC-10F module. Refer to Figure 2-10 and Figure 2-11.

FIGURE 2-11: Wiring NACs and IDCs for Class A Operation

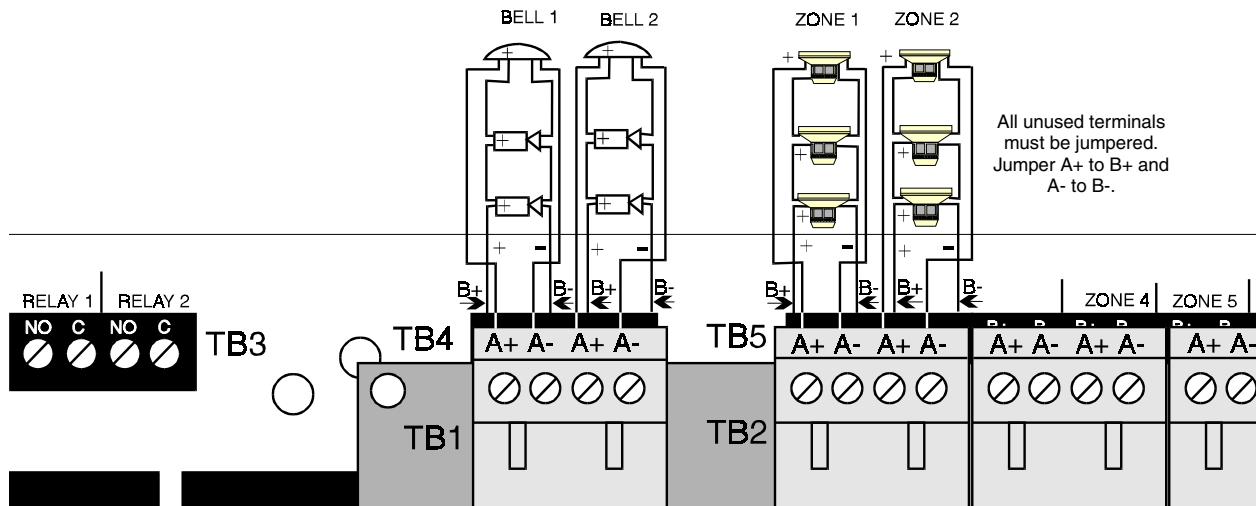

Installation of Optional Modules

NAC-REM (NAC/Relay Expander Module)

The NAC-REM Module can be used to add two Style Y (Class B) or Style Z (Class A) NACs (1.5 amps maximum each) and two Form-C relays to the MS-5210UD. Connector J1 of the NAC-REM module plugs into connector J7 which is located at the top left corner of the MS-5210UD main circuit board.

Install the two supplied metal standoffs into the FACP main circuit board. Ensure that the metal standoff is installed in the position indicated in Figure 2-12. Carefully align the two connectors and press the NAC-REM module securely into place. Make certain the pins are properly aligned to prevent bending or breaking of any pins. It is important that the supplied screw and washer be used to secure the module to the metal standoff. This is necessary in order to help protect against electrical transients.

FIGURE 2-12: Installation & Wiring of NAC-REM Module

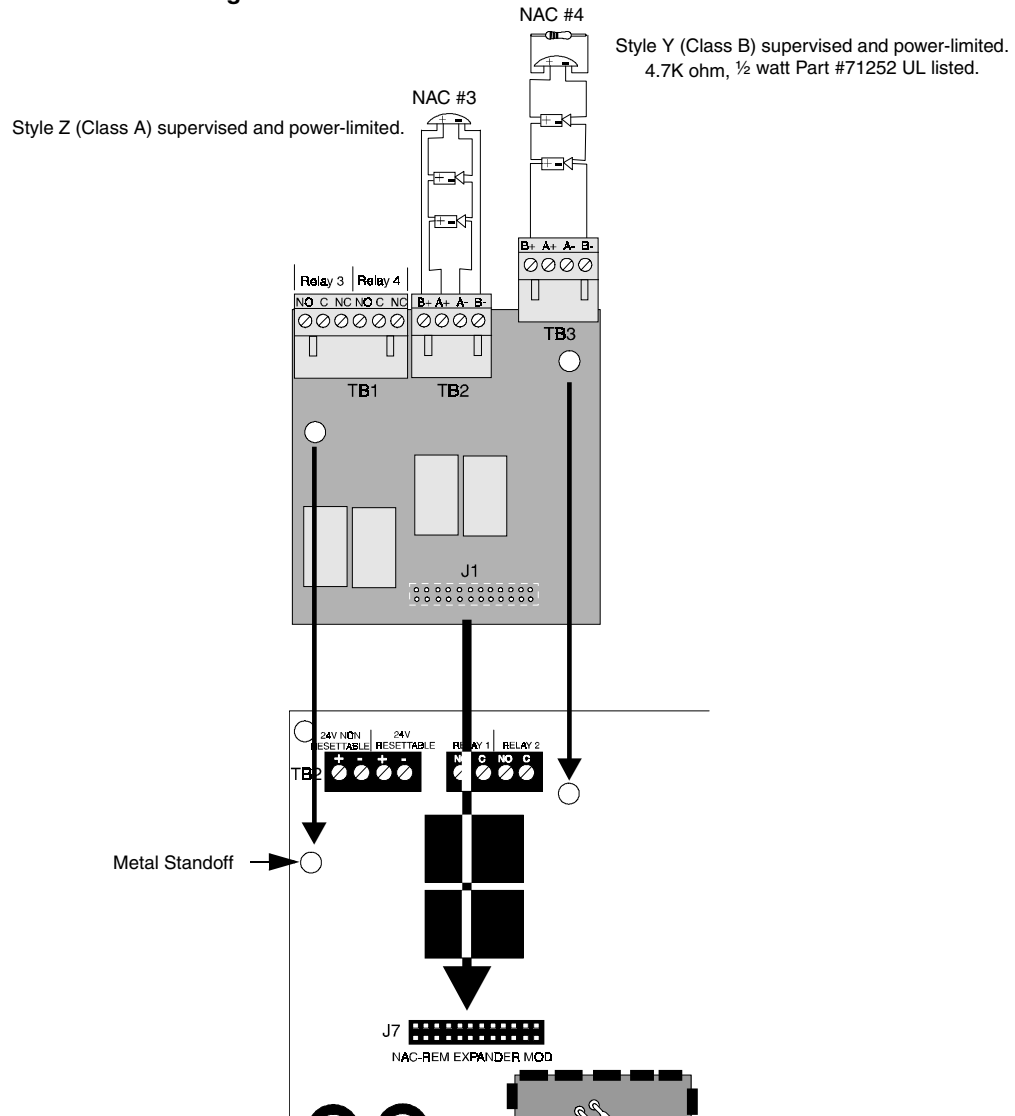

PRT-24 Printer Interface Module

A remote printer may be permanently or temporarily connected to provide a hardcopy printout of normal current system status and activity, program entries, history file, troubleshoot mode voltages and walktest data. The PRT-24 provides an EIA-232 conversion to adapt to most 40 and 80 column printers.



CAUTION: DO NOT connect a printer to the Fire Alarm Control Communicator if a ground fault exists on the panel. Circuit damage may result.

Installation - Remote printers require a separate external primary power source. Also required is the PRT-24 which includes the Printer Interface Module and a 6-foot (1.83 m) interface cable prewired to a DB25 connector. Connect the interface cable to the PRT-24 as illustrated in Figure 2-13. Insert the two supplied standoffs into mounting holes near the J4 connector on the main circuit board. Connect the Printer Interface board to J4 on the main circuit board, press onto standoffs and connect the attached cable to the serial EIA-232 port on the printer. The printer may be placed a maximum of 50 feet (15.24 m) from the panel. Note that a ground fault may occur on the control panel when this connection is made. For this reason, it is important that there be no preexisting ground fault on the panel. *For permanent printer connection, a ground fault is not allowed.*

Printer Configuration - The PRT-24 is required. Also refer to the documentation supplied with your printer. Set the printer's options as listed in Table 2-1 . Baud rate is programmable to 2400, 4800 or 9600.

TABLE 2-1: Printer Settings

Typical Printer	
Under the MENU area:	
COMMUNIC. SETUP:	
DATA BITS:	7
PARITY:	EVEN
STOP BIT:	1 STOP
BAUD RATE:	MUST MATCH FACP SETTING

FIGURE 2-13: Remote Printer Connections

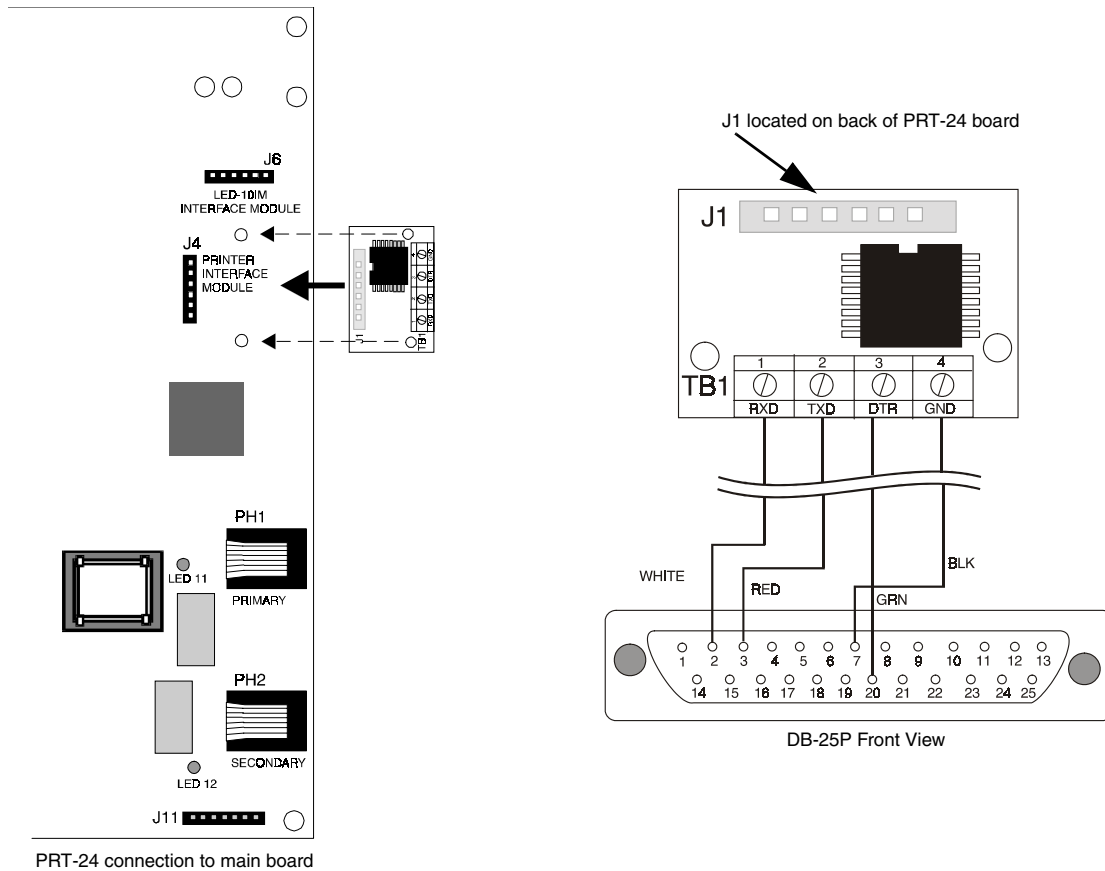

LED-10IM - EIA-485 Interface Module

The LED-10IM Interface Module provides an EIA-485 port to support the LED-10 Series Remote Annunciator, LDM Series Annunciator, AFM Series Annunciator and the ACM-8RF Relay Module and supervises the EIA-485 wiring for open circuits. The LED-10IM mounts to connector J6 in the upper right corner of the main board.

Install the two supplied standoffs into the FACP main circuit board. Ensure that the metal standoff is installed in the position indicated in Figure 2-14. Carefully align the two connectors and press the LED-10IM module securely into place. Make certain the pins are properly aligned to prevent bending or breaking of any pins. It is important that the supplied screw and washer be used to secure the module to the metal standoff. This is necessary in order to help protect against electrical transients.

FIGURE 2-14:LED-10IM Installation

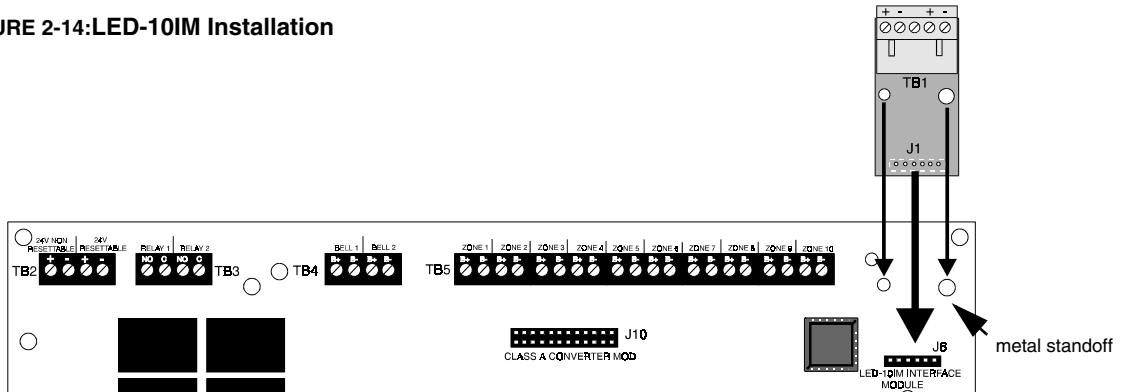

LED-10 Series Remote LED Annunciator

The LED-10 Series Annunciator connects to the MS-5210UD via the LED-10IM Interface Module. It is recommended that overall foil/braided-shielded, twisted pair cable with a maximum length of 6,000 feet (1,800 m) @ 18 AWG (0.75 mm²) be used. Regulated power can be supplied by the MS-5210UD or a remote UL listed filtered, regulated power supply such as the Fire•Lite FCPS-24.

FIGURE 2-15:Wiring LED-10IM to LED-10 Series

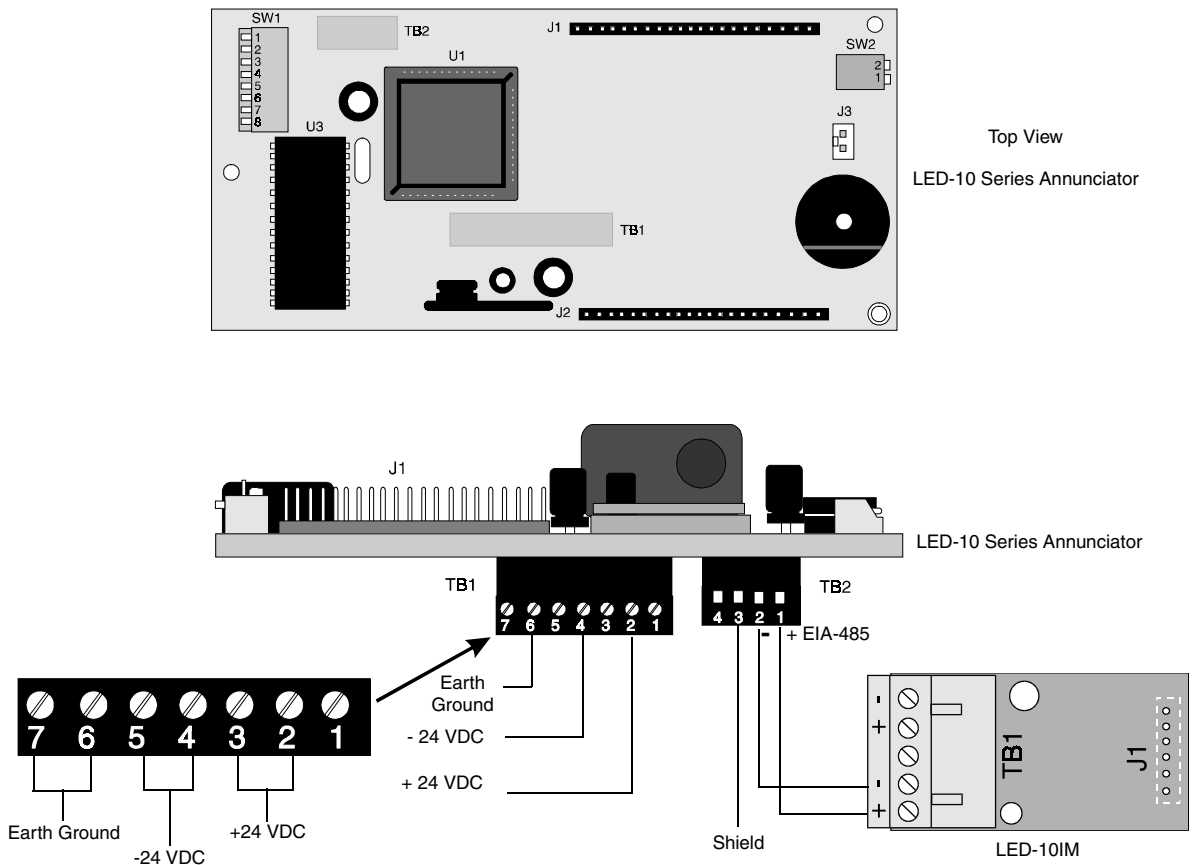

ACM-8RF Remote Relay Module

The ACM-8RF Module provides eight Form-C relays with contacts rated for 5.0 amps. Relays can be assigned to each of the ten Initiating Device Circuits (two ACM-8RF relay modules are required). The module is installed on the EIA-485 line using the LED-10IM Interface Module. Communication wiring is supervised by the FACP. Power for the module must be power-limited. Refer to the ACM-8RF Manual for UL power-limited wiring requirements and switch SW4 receive/transmit selection option.

Removable terminal blocks are provided for ease of installation and servicing. DIP switch SW3 allows assignment of relays to FACP IDCs. The ACM-8RF module can be mounted remotely in an ABS-8RF annunciator surface-mount backbox.

ACM-8RF Address and SW3 DIP Switch Settings - Each of the ten MS-5210UD IDCs can be assigned to an ACM-8RF relay. Two relay modules are required, with both set to the same address. Use the decade rotary switches to set the address (i.e. for address '01', position the first [left] switch so the arrow points to '0' and the second [right] switch so the arrow points to '1'). “Level Three - Option Module Selections” on page 60, Annunciator Maximum Monitored Address (02-03).

- ✓ To assign the first eight relays of the first ACM-8RF Relay Module to FACP IDCs 1 through 8, set ACM-8RF SW3 DIP switches 2 and 5 ON and 1, 3, 4, 6, 7 and 8 OFF.
- ✓ To assign the first two relays of the second ACM-8RF Relay Module to FACP IDCs 9 and 10, set ACM-8RF SW3 DIP switches 3 and 5 ON and 1, 2, 4, 6, 7 and 8 OFF.

FIGURE 2-16:ABS-8R Enclosure

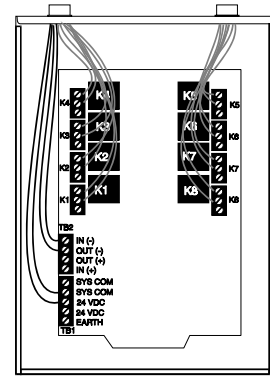
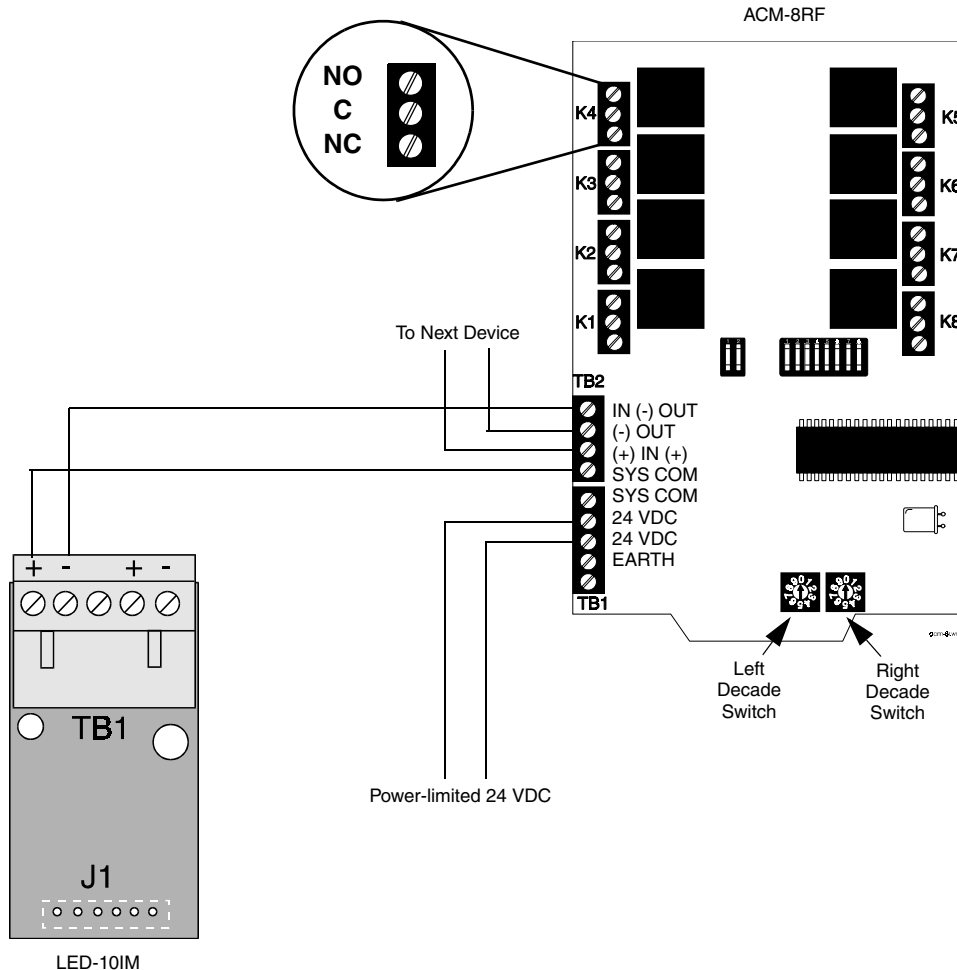

FIGURE 2-17:Wiring LED-10IM to ACM-8RF



LDM-32F Lamp Driver Module

The Lamp Driver Module is used to provide an interface to a custom graphic annunciator. The LDM-32F has 32 alarm lamp/LED driver outputs which sink current to system common (-) on activation. A single positive (+) voltage is required to supply total operating power for all lamps or LEDs when all drivers are activated. The LDM-32F provides a separate driver for system trouble and inputs for a local lamp test switch. A maximum of 16 external control switches may be wired to the LDM-32F. DIP switch SW3 is used to enable or disable the onboard piezo sounder, enable remote switch functions, select a flashing LED function for new alarms and troubles and other functions. A green ON LINE LED flashes to indicate ongoing communications with the host FACP. The LDM-32F is supplied with four standoffs and screws for mounting to a CHS-4L chassis or custom backbox.

The LDM-32F is installed on the EIA-485 line using the LED-10IM Interface Module. Communications wiring is supervised by the FACP. Power for the module must be power-limited.

LDM-32F Switch Settings - Use the decade rotary switches to set the address (i.e. for address '02', position switch SW1 [top] so the arrow points to '2' and switch SW2 [bottom] so the arrow points to '0').

FIGURE 2-18:Wiring LED-10IM to LDM-32F

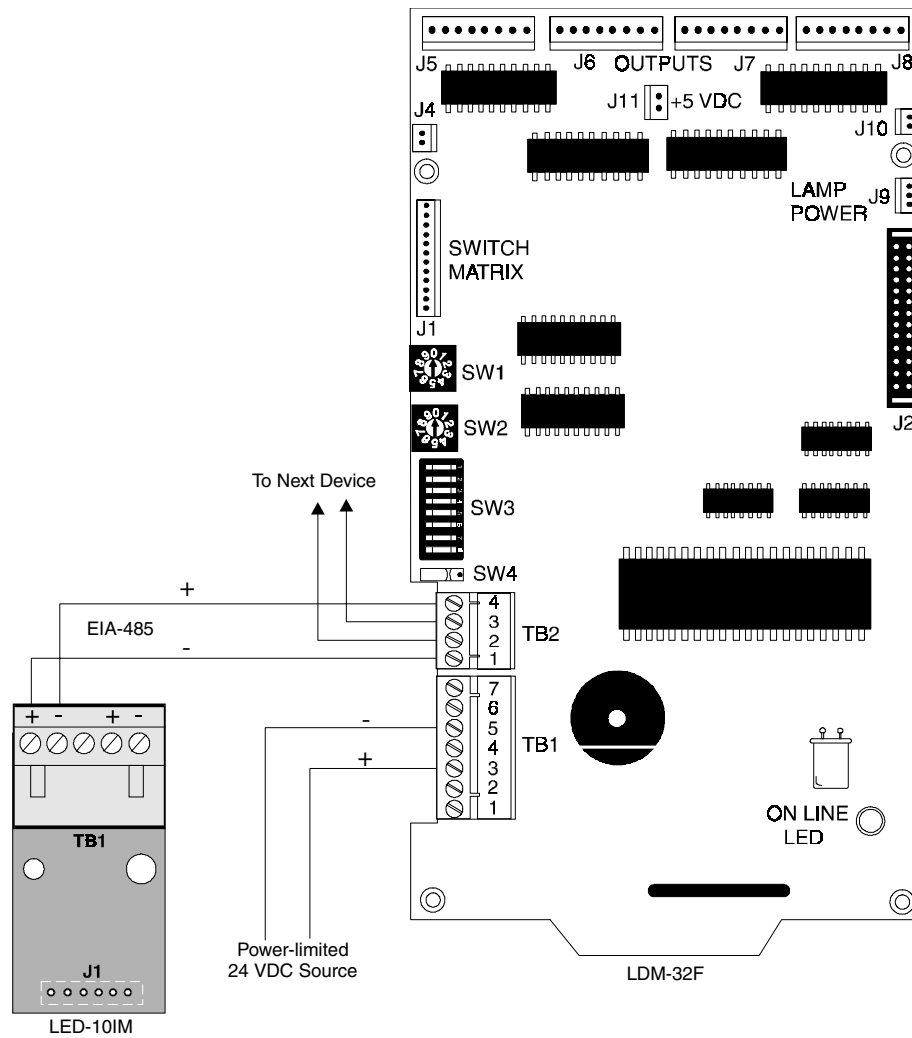

ACM-16ATF and AFM-16ATF Annunciators

The Annunciator Control Modules-16ATF and 16ATF each contain 16 red alarm and 16 yellow trouble LEDs, a system trouble LED, an ON LINE/POWER LED and a local piezo sounder with switches for FACP Acknowledge, Silence, Reset and Drill. The ACM-16ATF has rotary address switches and is installed on the EIA-485 line using the LED-10IM Interface Module.

AFM-16AF Annunciator

The Annunciator Fixed Module-16AF has 16 red alarm LEDs. The annunciator address is fixed at '1' and communication is via the EIA-485 line using the LED-10IM Interface Module. The Local Silence/Acknowledge switch functions as a local lamp test and silence for the annunciator piezo sounder. LEDs include ON LINE/POWER and System Trouble.

FIGURE 2-19:Wiring LED-10IM to ACM-16ATF

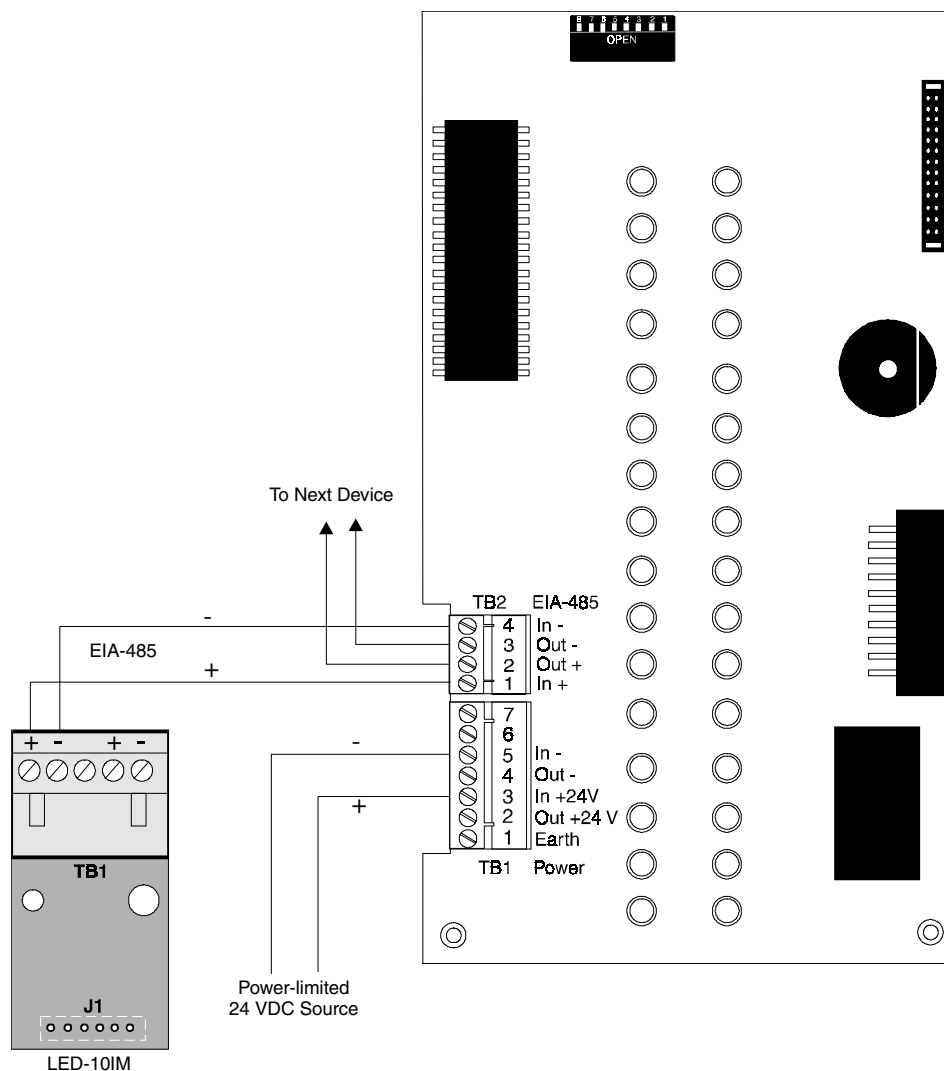

CHAPTER 3 *Programming Instructions*

This section describes programming the panel from the onboard keyboard or the remote site upload/download software which allows programming the control panel off premises. Programming of the control panel is possible at any time except when an alarm condition is present or during a fire drill.

The control panel has been designed for many different types of applications. After examining your specific application, review the programming options and choose the entries best suited for your system.

The control panel has a built-in intelligent programmer. All programming selections are stored in nonvolatile Electrically-Erasable Programmable Read-Only Memory (EEPROM). This ensures that the control panel will remember all entries made in programming mode even if both AC and battery power are removed. Invalid entries cause a 'beep' from the onboard piezo sounder.

The user **must** program the primary and secondary phone numbers, account numbers and 24 hour test report times for each central station account and the current time and date. The control panel comes with factory chosen options/features already programmed. Other options/features may be programmed if desired. If all factory default settings are acceptable, programming is complete.

Successful entry into Program Mode from the keypad shuts off the fire protection and places the panel into trouble. A 'system off normal' message is transmitted to the central station. Programming via the PK-5210UD upload/download software is accomplished with the fire protection active/on.

3.1 Entering Program Mode

Program Mode is divided into four levels:

1. Main Panel Options
2. Event Codes/Transmission Formats
3. Option Module Selections
4. Upload/Download

Each level of Program Mode is entered by pressing the **MODE** key and then keying in the program mode entry code (**7764**) and pressing the **[ENTER/STORE]** key.

☛ **7764** spells **PROG** on a Touch-Tone phone®

If an incorrect key is entered, reenter the proper 4-digit code before pressing the **[ENTER/STORE]** key. Note that as information is entered into the control panel, the digits will scroll across the display from right to left:

```

---7
--77
-776
7764
    
```

You are allowed a pause of up to 10 seconds in between each number while entering the code. After pressing the **[ENTER/STORE]** key, the control panel will be in Program Mode and will display **P--1**, with the 1 flashing. If the **[ENTER/STORE]** key is pressed, Level 1 (Main Panel Options) will be selected for programming. If Level 2 (Event Codes/Transmission Formats), Level 3 (Option Module Selections) or Level 4 (Upload/Download) is keyed in and then the **[ENTER/STORE]** key pressed, the corresponding Level will be selected for programming. You are allowed up to ten minutes of idle time at this point before starting your programming, otherwise, the control panel will return to Normal Mode. You also have a maximum of 10 minutes between any key stroke. All entries made prior to the 10 minute time-out are valid and are stored.

Switch Functions

Once in any of the four levels of the Programming Mode, the control panel will:

- Blink the Trouble LED
- Activate the trouble relay
- Disable the Notification Appliance Circuit(s)
- Disable the alarm relay
- Display **00_F**
- Ignore all other keys other than those mentioned in this section
- Continue to communicate any events not previously acknowledged at a central station prior to entering Programming Mode

While in any of the four levels of Programming Mode, the first three locations on the left of the display represent the memory address and the last location (farthest right) represents the contents of the memory address. The first address displayed is shown below:

00_F
(address)(data)

3.2 Switch Functions

The function of each switch in program mode is illustrated below:

FIGURE 3-1: Control Panel Keypad

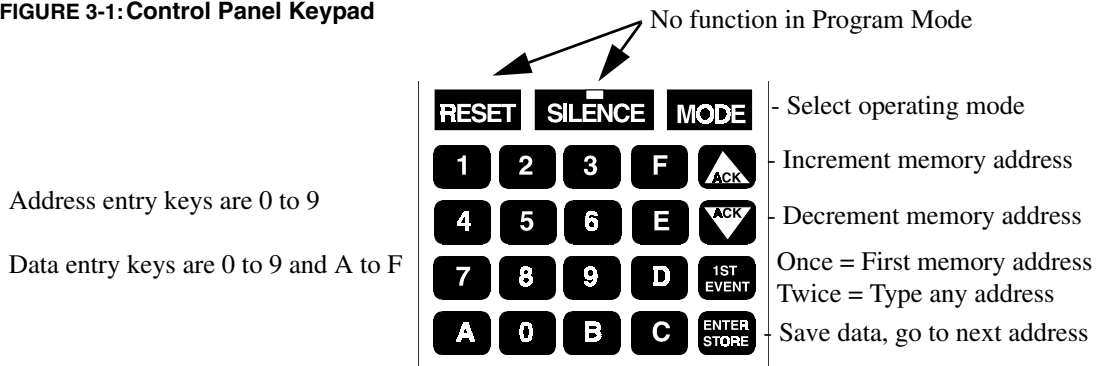

3.3 Program Options

3.3.1 Level 1 - Main Panel Options

Note that the factory default setting for Location 56 is '0' for Control Panel only. This keeps the communicator off until location 56 is changed to '1' for panel/communicator. Once location 56 is set to '1' and a valid phone number is entered, entry into the program mode will cause transmission of the 'System Off Normal' report.

Primary Central Station Phone Number (00-15)

The first sixteen addresses, 00-15, are factory set to 'F' (from **00_F** to **15_F**). Programming is typically done as follows:

- ✓ If your phone number is 484-7161, press **4**.
- ✓ The display will read **00_4**.
- ✓ Press [**ENTER/STORE**] to save the entry to memory and increment to the next address **01_F**.

Program Options

- ✓ Enter the remaining numbers in their respective addresses as shown below:

Entry	4	8	4	7	1	6	1	F	F	F	F	F	F	F	F	
Address	00	01	02	03	04	05	06	07	08	09	10	11	12	13	14	15

Valid entries for both the primary and secondary phone numbers are 0 to 9 and A to F with the numeric digits as dialed numbers and the hexadecimal digits representing the following functions:

- A = * on a Touch-Tone phone keypad
- B = # on a Touch-Tone phone keypad
- C = look for secondary dial tone for up to two seconds (then dial anyway)
- D = three second pause
- E = five second pause
- F = end of phone number (Note: F must be entered in all unused phone number locations)

Primary Central Station Number Communication Format (16)

One location is needed to select the Communication Format to the primary phone number. Address 16 is used for this purpose. The default (factory setting) for this address is 'E', which is Contact ID Format. You may enter '0' through 'D' in place of the default, then press [ENTER/STORE]. Choose from the list of formats below:

- 0: 4+1 Ademco Express Standard, DTMF, 1400/2300 ACK
- 1: 4+2 Ademco Express Standard, DTMF, 1400/2300 ACK
- 2: 3+1 Standard 1800 Hz Carrier, 2300 Hz ACK
- 3: 3+1 Expanded 1800 Hz Carrier, 2300 Hz ACK
- 4: 3+1 Standard 1900 Hz Carrier, 1400 Hz ACK
- 5: 3+1 Expanded 1900 Hz Carrier, 1400 Hz ACK
- 6: 4+1 Standard 1800 Hz Carrier, 2300 Hz ACK
- 7: 4+1 Expanded 1800 Hz Carrier, 2300 Hz ACK
- 8: 4+1 Standard 1900 Hz Carrier, 1400 Hz ACK
- 9: 4+1 Expanded 1900 Hz Carrier, 1400 Hz ACK
- A: 4+2 Standard 1800 Hz Carrier, 2300 Hz ACK
- B: 4+2 Expanded 1800 Hz Carrier, 2300 Hz ACK
- C: 4+2 Standard 1900 Hz Carrier, 1400 Hz ACK
- D: 4+2 Expanded 1900 Hz Carrier, 1400 Hz ACK
- E: Contact ID, DTMF, 1400/2300 ACK
- F: Future use

Note: Consult you Central Station for proper selection or consult our factory representatives. For any format chosen, the control panel automatically programs all of the event codes. See Table 3-3 through Table 3-8.



CAUTION: Default entries for event codes (as shown in Table 3-3 through Table 3-8) are programmed into memory each time address '16' is altered. Be certain to double check entries after programming the zone functions, addresses 64 - 73. Program the format first, then program the zone(s) function. Do not alter while the communicator is active.

Primary Central Station Number Account Code (17-20)

The four locations at addresses 17-20 default to all '0s'. Valid entries are 0-9 and A-F. The number of digits entered must match the format selection. If programming '2, 3, 4 or 5' into address 16, enter three digits (one digit each in locations 17, 18 and 19 - location 20 is ignored). If programming '0, 1, 6, 7, 8, 9, A, B, C, D or E' into address 16, enter four digits (one digit each in locations 17, 18, 19 and 20).

Program Options

Primary Central Station Number 24 Hour Test Time (21-24)

Use military time when entering the 24 hour 'test' time. The 24 hour test report to phone number 1 takes up four locations, from addresses 21-24. The default is 00:00 (12:00 midnight). The limits for each location are as follows (do not use values of A-F as entries):

- 21: enter 0, 1 or 2
- 22: enter 0-9
- 23: enter 0-5
- 24: enter 0-9

Primary Central Station Number 24/12/8/6 Hour Test Time Interval (25)

The test report sent to the Primary phone number may be sent every 6, 8, 12 or 24 hours. If the message is to be sent every 24 hours, leave the factory default entry of '0'. If other test report times are needed, enter 1=12hr, 2=8hr or 3=6hr.

Secondary Central Station Phone Number (26-41)

Programming is similar to programming the primary phone number located at addresses 00 - 15. The defaults are also all 'Fs'.

Entry	F	F	F	F	F	F	F	F	F	F	F	F	F	F	F	
Address	26	27	28	29	30	31	32	33	34	35	36	37	38	39	40	41

Secondary Central Station Number Communication Format (42)

Programming is the same as the primary number's Communication Format at address 16. Default entry is 'E', Contact ID Format. Choose one entry from the list below:

- 0: 4+1 Ademco Express Standard, DTMF, 1400/2300 ACK
- 1: 4+2 Ademco Express Standard, DTMF, 1400/2300 ACK
- 2: 3+1 Standard 1800 Hz Carrier, 2300 Hz ACK
- 3: 3+1 Expanded 1800 Hz Carrier, 2300 Hz ACK
- 4: 3+1 Standard 1900 Hz Carrier, 1400 Hz ACK
- 5: 3+1 Expanded 1900 Hz Carrier, 1400 Hz ACK
- 6: 4+1 Standard 1800 Hz Carrier, 2300 Hz ACK
- 7: 4+1 Expanded 1800 Hz Carrier, 2300 Hz ACK
- 8: 4+1 Standard 1900 Hz Carrier, 1400 Hz ACK
- 9: 4+1 Expanded 1900 Hz Carrier, 1400 Hz ACK
- A: 4+2 Standard 1800 Hz Carrier, 2300 Hz ACK
- B: 4+2 Expanded 1800 Hz Carrier, 2300 Hz ACK
- C: 4+2 Standard 1900 Hz Carrier, 1400 Hz ACK
- D: 4+2 Expanded 1900 Hz Carrier, 1400 Hz ACK
- E: Contact ID, DTMF, 1400/2300 ACK
- F: Future use

Note: Consult your Central Station for proper selection or consult our factory representatives. For any format chosen, the control panel automatically programs all of the event codes. See Table 3-3 through Table 3-8.

CAUTION: *Default entries for event codes (as shown in Table 3-3 through Table 3-8) are programmed into memory each time address '42' is altered. Be certain to double check entries after programming the zone functions, addresses 64 - 73. Program the format first, then program the zone(s) function. Do not alter entry while the communicator is active.*



Program Options

Secondary Central Station Number Account Code (43-46)

Four locations at addresses 43-46 default to all '0s'. Valid entries are 0-9 and A-F. The number of digits entered must match the format selection. If programming '2, 3, 4 or 5' into address 42, enter three digits (one digit each in locations 43, 44 and 45 - location 46 is ignored). If programming '0, 1, 6, 7, 8, 9, A, B, C, D or E' into address 42, enter four digits (one digit each in locations 43, 44, 45 and 46).

Secondary Central Station Number 24-Hour Test Time (47-50)

Use military time when entering the 24 hour 'test' time. The 24 hour test report to phone number 2 takes up four locations, from addresses 47-50. The default is 00:00 (12:00 midnight). The limits for each location are as follows (do not use values of A-F as entries):

47: enter 0, 1 or 2

48: enter 0-9

49: enter 0-5

50: enter 0-9

Secondary Central Station Number 24/12/8/6 Hour Test Time (51)

The test message sent to the Secondary phone number may be sent every 6, 8, 12 or 24 hours. If the message is to be sent every 24 hours, leave the factory default entry of '0'. If other test report times are needed, enter 1=12hr, 2=8hr or 3=6hr.

Alarm Presignal (52)

Alarm Presignal is used to delay Notification Appliance Circuit(s) activation while allowing for visual verification by a person. Once a zone triggers an alarm, the mainboard piezo sounder and the annunciator piezo sounder turn on steady, the alarm LEDs on the FACP and annunciator flash, the FACP display indicates the activated zone, the annunciator zone LED flashes and the Notification Appliance Circuits are held off for 15 seconds. During this time, if the Silence or Acknowledge switch is pressed, the piezos are silenced and the notification appliances may be held off for up to three minutes. (See Alarm Presignal Delay Timer Address 53-55). After the programmed delay period, the notification appliances will activate if the source of the alarm is not cleared. *Presignal does not function for zones defined as Waterflow, Supervisory, Process Monitoring or zones defined as Remote Switches.* Factory default is '0' for no alarm presignal. Enter '1' to select alarm presignal. During alarm presignal, access to other modes is prevented and the communicator will not transmit a signal to the central station signifying that the alarm presignal sequence has been initiated.



CAUTION: ACM-8RF relays will activate during the Alarm Presignal sequence.

Alarm Presignal Delay Timer (53-55)

The Alarm Presignal Timer is factory set to 120 seconds (2 minutes), with addresses 53=1, 54=2 and 55=0. The timer may be programmed from 0 to 179 seconds. Location 52 must be set to '1'.

Communicator/Fire Panel Selection (56)

Leaving address 56 at '0' causes the control panel to operate as a *fire panel only*. Selecting '1' will make it operate as a *fire panel/communicator*.

Backup Reporting (57)

Leaving address 57 at '0' means that reports will be transmitted to the secondary Central Station phone number only if attempts to communicate to the primary Central Station phone number are unsuccessful. Programming a '1' causes all reports to be transmitted to both the primary and secondary Central Station phone numbers. Programming a '2' causes reports to go to the first available receiver.



CAUTION: Do not alter this entry while the communicator is active.

Touchtone/Rotary Select for Primary Phone (58)

A '0' programmed in this address by the factory triggers Touchtone dialing over the primary phone line. Select '1' for rotary dialing.

Program Options

Make/Break Ratio for Primary Phone (59)

Use this address only if you have chosen '1' for address 58. The Make/Break ratio is factory set to '0' which is 67/33 ratio, but may be changed to '1' which is 62/38 ratio.

Touchtone/Rotary Select for Secondary Phone (60)

A '0' programmed in this address by the factory triggers Touchtone dialing over the secondary phone line. Select '1' for rotary dialing.

Make/Break Ratio for Secondary Phone (61)

Use this address only if you have chosen '1' for address 60. The Make/Break ratio is factory set to '0' which is 67/33 ratio, but may be changed to '1' which is a 62/38 ratio.

Address (62)

Leave entry as default of '0'.

Address (63)

Leave entry as default of '0'.

Zones 1 through 10 Function Selection (64-73)

The ten zones on the control panel may be programmed as shown in Table 3-1 . Program entries alter zone function, transmittal priority and, as a result of altering the zone definition, the transmitted event code message is automatically changed. Remote switch entries 9, A, B and C cause the zone function to be altered to match the FACP keypad entries. Initial closure (or shorting) of a switch causes the switch function to occur. The switch must be returned to its normal position.

TABLE 3-1: Zone Functions

<u>Program Entry</u>	<u>Function</u>
0	Operate 2-wire smoke detectors
1	Pull Station
2	Normally-Open Contact Device (heat detector, 4-wire smoke, etc.)
3	Supervisory
4	Supervisory, autoresettable. Self restore function, is not latched by the control panel
5	Waterflow, silenceable. Silencing of Silenceable Notification Appliance Circuits allowed
6	Waterflow, nonsilenceable. Silencing of Silenceable Notification Appliance Circuits not allowed. Must clear waterflow alarm condition and press reset key
7	Critical and noncritical process monitoring
8	Autoresettable process monitoring
9	Remote reset switch ¹
A	Remote silence switch ¹
B	Remote acknowledge switch ¹
C	Remote manual evacuate (drill) switch ¹

1. For remote switch applications, use Fire•Lite P/N: AKS-1F or equivalent UL listed switch.

Zone 1 Function Selection (64)

Factory default for zone 1 is '0' for 2-wire smoke detector. Enter '1' for Pull Station; '2' for Normally-Open contact device; '3' for Supervisory; '4' for Supervisory, autoresettable; '5' for Waterflow, silenceable; '6' for Waterflow, nonsilenceable; '7' for critical and noncritical process monitoring; '8' for autoresettable process monitoring; '9' for remote reset switch; 'A' for remote silence switch; 'B' for remote acknowledge switch; or 'C' for remote manual evacuate (drill) switch.

Program Options

Zone 2 Function Selection (65)

Factory default for zone 2 is '0' for 2-wire smoke detector. Enter '1' for Pull Station; '2' for Normally-Open contact device; '3' for Supervisory; '4' for Supervisory, autoresettable; '5' for Waterflow, silenceable; '6' for Waterflow, nonsilenceable; '7' for critical and noncritical process monitoring; '8' for autoresettable process monitoring; '9' for remote reset switch; 'A' for remote silence switch; 'B' for remote acknowledge switch; or 'C' for remote manual evacuate (drill) switch.

Zone 3 Function Selection (66)

Factory default for zone 3 is '0' for 2-wire smoke detector. Enter '1' for Pull Station; '2' for Normally-Open contact device; '3' for Supervisory; '4' for Supervisory, autoresettable; '5' for Waterflow, silenceable; '6' for Waterflow, nonsilenceable; '7' for critical and noncritical process monitoring; '8' for autoresettable process monitoring; '9' for remote reset switch; 'A' for remote silence switch; 'B' for remote acknowledge switch; or 'C' for remote manual evacuate (drill) switch.

Zone 4 Function Selection (67)

Factory default for zone 4 is '0' for 2-wire smoke detector. Enter '1' for Pull Station; '2' for Normally-Open contact device; '3' for Supervisory; '4' for Supervisory, autoresettable; '5' for Waterflow, silenceable; '6' for Waterflow, nonsilenceable; '7' for critical and noncritical process monitoring; '8' for autoresettable process monitoring; '9' for remote reset switch; 'A' for remote silence switch; 'B' for remote acknowledge switch; or 'C' for remote manual evacuate (drill) switch.

Zone 5 Function Selection (68)

Factory default for zone 5 is '0' for 2-wire smoke detector. Enter '1' for Pull Station; '2' for Normally-Open contact device; '3' for Supervisory; '4' for Supervisory, autoresettable; '5' for Waterflow, silenceable; '6' for Waterflow, nonsilenceable; '7' for critical and noncritical process monitoring; '8' for autoresettable process monitoring; '9' for remote reset switch; 'A' for remote silence switch; 'B' for remote acknowledge switch; or 'C' for remote manual evacuate (drill) switch.

Zone 6 Function Selection (69)

Factory default for zone 6 is '0' for 2-wire smoke detector. Enter '1' for Pull Station; '2' for Normally-Open contact device; '3' for Supervisory; '4' for Supervisory, autoresettable; '5' for Waterflow, silenceable; '6' for Waterflow, nonsilenceable; '7' for critical and noncritical process monitoring; '8' for autoresettable process monitoring; '9' for remote reset switch; 'A' for remote silence switch; 'B' for remote acknowledge switch; or 'C' for remote manual evacuate (drill) switch.

Zone 7 Function Selection (70)

Factory default for zone 7 is '0' for 2-wire smoke detector. Enter '1' for Pull Station; '2' for Normally-Open contact device; '3' for Supervisory; '4' for Supervisory, autoresettable; '5' for Waterflow, silenceable; '6' for Waterflow, nonsilenceable; '7' for critical and noncritical process monitoring; '8' for autoresettable process monitoring; '9' for remote reset switch; 'A' for remote silence switch; 'B' for remote acknowledge switch; or 'C' for remote manual evacuate (drill) switch.

Zone 8 Function Selection (71)

Factory default for zone 8 is '0' for 2-wire smoke detector. Enter '1' for Pull Station; '2' for Normally-Open contact device; '3' for Supervisory; '4' for Supervisory, autoresettable; '5' for Waterflow, silenceable; '6' for Waterflow, nonsilenceable; '7' for critical and noncritical process monitoring; '8' for autoresettable process monitoring; '9' for remote reset switch; 'A' for remote silence switch; 'B' for remote acknowledge switch; or 'C' for remote manual evacuate (drill) switch.

Zone 9 Function Selection (72)

Factory default for zone 9 is '0' for 2-wire smoke detector. Enter '1' for Pull Station; '2' for Normally-Open contact device; '3' for Supervisory; '4' for Supervisory, autoresettable; '5' for Waterflow, silenceable; '6' for Waterflow, nonsilenceable; '7' for critical and noncritical process monitoring; '8' for autoresettable process monitoring; '9' for remote reset switch; 'A' for remote silence switch; 'B' for remote acknowledge switch; or 'C' for remote manual evacuate (drill) switch.

Zone 10 Function Selection (73)

Factory default for zone 10 is '0' for 2-wire smoke detector. Enter '1' for Pull Station; '2' for Normally-Open contact device; '3' for Supervisory; '4' for Supervisory, autoresettable; '5' for Waterflow, silenceable; '6' for Waterflow, nonsilenceable; '7' for critical and noncritical process monitoring; '8' for autoresettable process monitoring; '9' for remote reset switch; 'A' for remote silence switch; 'B' for remote acknowledge switch; or 'C' for remote manual evacuate (drill) switch.

Note: Programming any zone to function as supervisory or supervisory autoresettable will cause the defaulted zone alarm event codes (see note in Table 3-2) to be automatically changed. The defaulted code of '1' is changed to '8' for formats 3+1 and 4+1 Standard and Expanded, 4+2 Expanded and 4+1 Express (refer to Table 3-3 and Table 3-6). The defaulted codes of 11 through 1A are changed to 81 through 8A accordingly for formats 4+2 Standard and 4+2 Express (refer to Table 3-4 and Table 3-7). Programming any zone to function as process monitoring (Zone Function Selections 7 or 8) will cause the alarm event code to be automatically programmed as '0' or '00' which disables the report. Be certain to reprogram the alarm event code for each process monitoring zone. Restoral codes remain unchanged from factory defaults.

When using Contact ID Format, zone alarm and zone restoral event codes change automatically as shown in Table 3-2 . Be certain to reprogram alarm event codes when selecting process monitoring functions. Zone fault and disable event codes may also be user programmed (refer to “Ademco Contact ID Format Event Code Descriptions” on page 109).

Programming a zone as a remote switch causes no transmission of an alarm or alarm restoral event code. The zone wiring continues to be supervised for opens whereas a short simulates closure of a reset, silence, drill or acknowledge switch. Zone fault and zone restoral codes continue to be transmitted.

TABLE 3-2: Event Code Changes for ID Contact Format

Zone Function Selection	Function	Zone Alarm/Restoral Event Code
0	2-wire Smoke	111
1	Pull Station	115
2	N.O. Contact Device	110
3	Supervisory	200
4	Autoresettable Supervisory	200
5	Waterflow (silenceable)	113
6	Waterflow (nonsilenceable)	113
7	Process Monitoring	000 ¹
8	Autoresettable Process Monitoring	000 ¹
9	Reset Switch	N/A
A	Silence Switch	N/A
B	Acknowledge Switch	N/A
C	Drill Switch	N/A

1. *Be certain to program appropriate process monitoring functions (refer to “Ademco Contact ID Format Event Code Descriptions” on page 109).*

Waterflow Retard Timer (74-75)

A delay may be added prior to declaring a Waterflow type of alarm. Delays up to 89 seconds are allowed. The default for addresses 74 and 75 are '00' (no additional delay). Valid entries for 74 are 0 through 8 and for 75 are 0 through 9. Program an entry into these addresses only if entering a '5' or '6' in any of the addresses 64 through 73. *Be careful to include any built-in delays of the waterflow device.*

Program Options

Alarm Verification (76)

Alarm verification works only on zones programmed as 2-wire smoke detector zones. After detecting an alarm, the panel removes power from all zones for six seconds, resetting all 2-wire smoke detectors. Power is reapplied and a 12 second retard period allows detectors to stabilize. During the retard/reset period of 18 seconds, subsequent alarms by the same initiating zone are ignored. An alarm detected on any other 2-wire detector zone during the retard period will cause immediate verified alarms. A subsequent alarm on the initiating zone occurring within the confirmation time will cause a verified alarm.



CAUTION: *Mixing devices on zones designated as 2-wire smoke zones is not recommended. The communicator will not transmit a signal to the central station signifying that alarm verification is in progress.*

Note that during the alarm verification period, access to other modes of operation is prevented.

FIGURE 3-2: Verification Timing Diagram

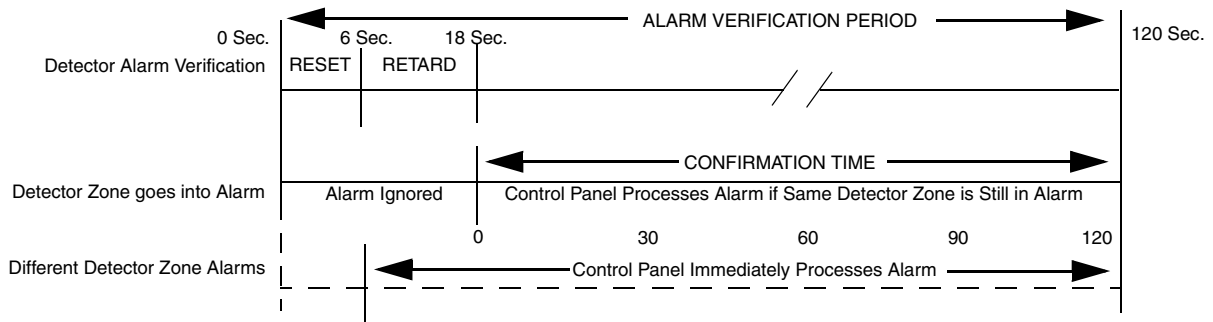

Factory default selection is no verification which is '0'. Entering a '1' enables verification. *Consult the Local Authority Having Jurisdiction (LAHJ) prior to altering this address.*

AC Loss Reporting Delay (77)

Enter a digit of 0 - 9 or A - F corresponding to the number of hours to be delayed in reporting the loss of AC power. Factory default is 6 hour delay. The valid entries are '0' = 6 hours, '1' = 7 hours, '2' = 8 hours, '3' = 9 hours, '4' = 10 hours, '5' = 11 hours, '6' = 12 hours, '7' = 15 hours, '8' = 16 hours, '9' = 17 hours, 'A' = 18 hours, 'B' = 19 hours, 'C' = 20 hours, 'D' = 21 hours, 'E' = 22 hours, 'F' = 23 hours.

Programmable Relay #1 (78)

Relay #1 on TB3 of the MS-5210UD main circuit board can be programmed to activate for any one of seven FACP conditions. The factory default for address 78 is '0' for activation on alarm. Program a '1' for supervisory, '2' for supervisory autoresettable, '3' for trouble, '4' for communication fail, '5' for process monitoring or '6' for process monitoring autoresettable.

Programmable Relay #2 (79)

Relay #2 on TB3 of the MS-5210UD main circuit board can be programmed to activate for any one of seven FACP conditions. The factory default for address 79 is '3' for activation on trouble. Program a '0' for alarm, '1' for supervisory, '2' for supervisory autoresettable, '4' for communication fail, '5' for process monitoring or '6' for process monitoring autoresettable.

Notification Appliance Circuit #1 Enable (80)

Notification Appliance Circuit #1 may be programmed as '0' for silenceable, '1' for nonsilenceable or '2' for disabled. Factory default is '0' for silenceable. *Note: Consult the Local Authority Having Jurisdiction (LAHJ) prior to altering this address.*

Silence Inhibit Notification Appliance Circuit #1 (81)

Setting address 81 to '1' prohibits silencing of Notification Appliance Circuit #1 for one minute after initiation of an alarm. Factory default is '0' for no silence inhibit of Notification Appliance Circuit #1.

Program Options

Autosilence Notification Appliance Circuit #1 (82)

Notification Appliance Circuit #1 may be autosilenced after a programmed time interval between 5 and 30 minutes. Enter '1' for 5 minute autosilence; '2' for 10 minute autosilence; '3' for 15 minute autosilence; '4' for 20 minute autosilence; '5' for 25 minute autosilence; or '6' for 30 minute autosilence. The factory default is '0' for no autosilence.

Coding of Notification Appliance Circuit #1 (83)

Coding of Notification Appliance Circuit #1 is selectable for the following: '1' for March Time (120ppm); '2' for California (10 seconds On, 5 seconds Off); or '3' for Temporal (½ second On, ½ second Off, ½ second On, ½ second Off, ½ second On, 1½ seconds Off and then repeat). Factory default is '0' for steady (no coding).

Notification Appliance Circuit #2 Enable (84)

Notification Appliance Circuit #2 may be programmed as '0' for silenceable, '1' for nonsilenceable or '2' for disabled. Factory default is '0' for silenceable. *Note: Consult the Local Authority Having Jurisdiction (LAHJ) prior to altering this address.*

Silence Inhibit Notification Appliance Circuit #2 (85)

Setting address 85 to '1' prohibits silencing of Notification Appliance Circuit #2 for one minute after initiation of an alarm. Factory default is '0' for no silence inhibit of Notification Appliance Circuit #2.

Autosilence Notification Appliance Circuit #2 (86)

Notification Appliance Circuit #2 may be autosilenced after a programmed time interval between 5 and 30 minutes. Enter '1' for 5 minute autosilence; '2' for 10 minute autosilence; '3' for 15 minute autosilence; '4' for 20 minute autosilence; '5' for 25 minute autosilence; or '6' for 30 minute autosilence. The factory default is '0' for no autosilence.

Coding of Notification Appliance Circuit #2 (87)

Coding of Notification Appliance Circuit #2 is selectable for the following: '1' for March Time (120ppm); '2' for California (10 seconds On, 5 seconds Off); or '3' for Temporal (½ second On, ½ second Off, ½ second On, ½ second Off, ½ second On, 1½ seconds Off and then repeat). Factory default is '0' for steady (no coding).

Trouble Reminder (88)

Factory default '0' disables the trouble reminder feature. Selecting '1' will cause a reminding beep (after the Silence or Acknowledge switch is pressed) every 15 seconds during an alarm and beep every two minutes during a trouble condition. The beeps from the onboard piezo sounder will occur until the alarm or fault is cleared.

Programming the Real-Time Clock and Calendar (89-999)

Entering an address greater than 88 will cause a display of the current time. On initial power-up, the clock will start running from the factory setting of 00:01 (military time). The far left digit will be flashing, indicating that this is the first digit to be programmed.

Note that the software for the MS-5210UD operates the internal clock based upon 60 Hz. The software for the MS-5210UDE operates the internal clock based upon 50 Hz.

- **Programming Hours and Minutes** - To program the first hour digit, press the corresponding number on the keypad and then press [ENTER/STORE]. For example, to program 08:00 AM, press '0' on the keypad and then [ENTER/STORE]. The digit 2nd from the left will start flashing. Enter the second hour digit and press [ENTER/STORE]. In the previous example, the number '8' would be pressed on the keypad followed by the [ENTER/STORE] key. This completes the Hours setting. The digit 2nd from the right should now be flashing on the display. Select the first digit for the minutes by pressing the corresponding number on the keypad and then the [ENTER/STORE] key. The digit on the far right of the display will now be flashing. Select the second digit for the minutes by pressing the corresponding number on the keypad and then the [ENTER/STORE] key. The Minutes setting is now complete. If during programming of the time an invalid digit is selected (i.e. 3 or higher for the first digit) the FACP piezo sounder will beep and the digit will continue to blink until a valid entry is made.

Program Options

- **Programming Year** - After entering the last digit corresponding to minutes (far right digit), the display will read 1996 with the digit '9', second from the right, flashing. Press [ENTER/STORE] if acceptable. To change the year, enter a digit. Entering a zero '0' will change the display to the year 2000. Press the [ENTER/STORE] key. Repeat for the digit to the far right.
- **Programming Month/Day** - After the year is entered, the display will show four digits representing the month and day of the software release date. The month is represented by the two digits on the left and the day by the two digits on the right. The digit on the far left will be flashing. The month and day are set the same way as the hours and minutes. Once the last digit corresponding to the day is entered, the display will show the contents of address '00'. The real time clock/calendar keeps track of leap years automatically.

End Programming/Exit to Alternate Program Level

Exit Programming Mode by pressing **MODE**, followed by the 4-digit code corresponding to an alternate mode of operation, then press [ENTER/STORE]. To enter a different Programming Level, press **MODE** and then press the [ENTER/STORE] key. The display will show **P__1** with the '1' flashing. Press the digit (2, 3 or 4) of the Programming Level to be accessed.

During Program Mode, if no key is pressed within 10 minutes, the panel will revert to Normal Mode.

3.3.2 Level Two - Event Codes/Transmission Formats

Each option of the Program Mode is entered by keying in the program mode entry code (**7764**) and pressing the [ENTER/STORE] key.

- **7764** spells PROG on a Touch-Tone® phone

If an incorrect key is entered, reenter the proper 4-digit code before pressing the [ENTER/STORE] key.

You are allowed a pause of up to 10 seconds in between each number while entering the code. After pressing the [ENTER/STORE] key, the control panel will be in Program Mode and display **P__1**, with the '1' flashing. Press **2** on the keypad and then the [ENTER/STORE] key to select the Event Code/Transmission Formats Level for programming. You are allowed up to ten minutes of idle time at this point before starting your programming, otherwise, the control panel will go back to Normal Mode. You also have a maximum of 10 minutes between any key stroke. All entries made prior to the 10 minutes time-out are valid and are stored.

Upon entering the Event Codes/Transmission Formats Level in programming mode, the following will be displayed on the FACP 7-Segment Display.

00_1
(address)(data)

The first three locations on the left of the display represent the memory address **00** of the Format Chart previously selected in address 16 of the Main Panel Options section of programming mode. The last location **1** (farthest right) represents the contents of memory address **00** which is the format setting. The only value which can be altered in the Format Charts is the setting which is the last digit to the right. To change the value, key in the new digit. Use the **Up** and **Down Arrow** keys to increment to the next address or decrement to the previous address.

When desired changes have been completed, exit programming mode by pressing the **MODE** key, followed by the 4-digit code for an alternate mode and then the [ENTER/STORE] key. To enter a different Programming Level, press **MODE** and then press the [ENTER/STORE] key. The display will show **P__2** with the '2' flashing. Press the digit (1, 3 or 4) of the Programming Level to be accessed. During Program Mode, if no key is pressed within 10 minutes, the panel will revert to Normal Mode.

The Format Charts which may be selected in the Main Panel Options (Level 1) section of the Programming Mode are shown on the following pages of this section. Format charts for the Primary and Secondary Central Station Numbers are included.

Program Options

3+1, 4+1 Express, 4+1 Standard and Expanded, 4+2 Expanded Formats

If '0, 2, 3, 4, 5, 6, 7, 8, 9, B or D' are entered for address 16 in Program Mode Level 1, the data shown in Table 3-3 is automatically programmed for the Primary Central Station phone number event codes. Enter '0' for the setting to disable the report.

TABLE 3-3: Event Codes, Primary Central Station Number

<u>Address</u>	<u>Description</u>	<u>Setting</u>
0	Primary # Zone 1 Alarm Code	1 ¹
1	Primary # Zone 2 Alarm Code	1 ¹
2	Primary # Zone 3 Alarm Code	1 ¹
3	Primary # Zone 4 Alarm Code	1 ¹
4	Primary # Zone 5 Alarm Code	1 ¹
5	Primary # Zone 6 Alarm Code	1 ¹
6	Primary # Zone 7 Alarm Code	1 ¹
7	Primary # Zone 8 Alarm Code	1 ¹
8	Primary # Zone 9 Alarm Code	1 ¹
9	Primary # Zone 10 Alarm Code	1 ¹
10	Primary # Zone 1 Disabled Code	4
11	Primary # Zone 2 Disabled Code	4
12	Primary # Zone 3 Disabled Code	4
13	Primary # Zone 4 Disabled Code	4
14	Primary # Zone 5 Disabled Code	4
15	Primary # Zone 6 Disabled Code	4
16	Primary # Zone 7 Disabled Code	4
17	Primary # Zone 8 Disabled Code	4
18	Primary # Zone 9 Disabled Code	4
19	Primary # Zone 10 Disabled Code	4
20	Primary # Drill Code	9
21	Primary # AC Fault Code	9
22	Primary # Zone 1 Fault Code	F
23	Primary # Zone 2 Fault Code	F
24	Primary # Zone 3 Fault Code	F
25	Primary # Zone 4 Fault Code	F
26	Primary # Zone 5 Fault Code	F
27	Primary # Zone 6 Fault Code	F
28	Primary # Zone 7 Fault Code	F
29	Primary # Zone 8 Fault Code	F
30	Primary # Zone 9 Fault Code	F
31	Primary # Zone 10 Fault Code	F
32	Primary # Earth Fault Code	6
33	Primary # Low Battery Fault Code	6
34	Primary # No Battery Fault Code	6
35	Primary # Telco Primary Line Fault Code	6
36	Primary # Telco Secondary Line Fault Code	6
37	Primary # NAC #1 Fault Code	6
38	Primary # NAC #2 Fault Code	6
39	Primary # NAC #3 Fault Code	6
40	Primary # NAC #4 Fault Code	6
41	Primary # NAC #1 Disable Code	4
42	Primary # NAC #2 Disable Code	4
43	Primary # NAC #3 Disable Code	4
44	Primary # NAC #4 Disable Code	4
45	Primary # Comm Trouble Primary # Code	6
46	Primary # Comm Trouble Secondary # Code	6
47	Primary # Printer Fault Code	6
48	Primary # Annunciator Fault Code	6
49	Primary # 485 Comm Trouble Code	6
50	Primary # System Off Normal Code	6

TABLE 3-3: Event Codes, Primary Central Station Number

<u>Address</u>	<u>Description</u>	<u>Setting</u>
51	Primary # Zone 1 Alarm Restore Code	E
52	Primary # Zone 2 Alarm Restore Code	E
53	Primary # Zone 3 Alarm Restore Code	E
54	Primary # Zone 4 Alarm Restore Code	E
55	Primary # Zone 5 Alarm Restore Code	E
56	Primary # Zone 6 Alarm Restore Code	E
57	Primary # Zone 7 Alarm Restore Code	E
58	Primary # Zone 8 Alarm Restore Code	E
59	Primary # Zone 9 Alarm Restore Code	E
60	Primary # Zone 10 Alarm Restore Code	E
61	Primary # Zone 1 Disabled Restore Code	5
62	Primary # Zone 2 Disabled Restore Code	5
63	Primary # Zone 3 Disabled Restore Code	5
64	Primary # Zone 4 Disabled Restore Code	5
65	Primary # Zone 5 Disabled Restore Code	5
66	Primary # Zone 6 Disabled Restore Code	5
67	Primary # Zone 7 Disabled Restore Code	5
68	Primary # Zone 8 Disabled Restore Code	5
69	Primary # Zone 9 Disabled Restore Code	5
70	Primary # Zone 10 Disabled Restore Code	5
71	Primary # Drill Restore Code	9
72	Primary # AC Fault Restore Code	9
73	Primary # Zone 1 Fault Restore Code	D
74	Primary # Zone 2 Fault Restore Code	D
75	Primary # Zone 3 Fault Restore Code	D
76	Primary # Zone 4 Fault Restore Code	D
77	Primary # Zone 5 Fault Restore Code	D
78	Primary # Zone 6 Fault Restore Code	D
79	Primary # Zone 7 Fault Restore Code	D
80	Primary # Zone 8 Fault Restore Code	D
81	Primary # Zone 9 Fault Restore Code	D
82	Primary # Zone 10 Fault Restore Code	D
83	Primary # Earth Fault Restore Code	A
84	Primary #Low Battery Fault Restore Code	A
85	Primary # No Battery Fault Restore Code	A
86	Primary # Telco Primary Line Fault Restore Code	A
87	Primary # Telco Secondary Line Fault Restore Code	A
88	Primary # NAC #1 Fault Restore Code	A
89	Primary # NAC #2 Fault Restore Code	A
90	Primary # NAC #3 Fault Restore Code	A
91	Primary # NAC #4 Fault Restore Code	A
92	Primary # NAC #1 Disable Restore Code	5
93	Primary # NAC #2 Disable Restore Code	5
94	Primary # NAC #3 Disable Restore Code	5
95	Primary # NAC #4 Disable Restore Code	5
96	Primary # Comm Trouble Primary # Restore Code	A
97	Primary # Comm Trouble Secondary # Restore Code	A
98	Primary # Printer Fault Restore Code	A
99	Primary # Annunciator Fault Restore Code	A
100	Primary # 485 Comm Trouble Restore Code	A
101	Primary # System Off Normal Restore Code	A
102	Primary # System Test Report	9
103	Primary # System Abnormal Test Report	F
104	Primary # Request for Up/Download	7
105	Primary # Successful Upload	7
106	Primary # Successful Download	7
107	Primary # Failed Up/Download	7

1. Zones programmed as supervisory alarm transmit as Code 8 instead of Code 1.

Program Options

4+2 Standard and 4+2 Express Formats

If '1, A or C' are entered for address 16 in Program Mode Level 1, the data shown in Table 3-4 is automatically programmed for the Primary Central Station phone number event codes. Enter '00' for the setting to disable the report.

TABLE 3-4: Event Codes, Primary Central Station Number

<u>Address</u>	<u>Description</u>	<u>Setting</u>
0-1	Primary # Zone 1 Alarm Code	11 ¹
2-3	Primary # Zone 2 Alarm Code	12 ¹
4-5	Primary # Zone 3 Alarm Code	13 ¹
6-7	Primary # Zone 4 Alarm Code	14 ¹
8-9	Primary # Zone 5 Alarm Code	15 ¹
10-11	Primary # Zone 6 Alarm Code	16 ¹
12-13	Primary # Zone 7 Alarm Code	17 ¹
14-15	Primary # Zone 8 Alarm Code	18 ¹
16-17	Primary # Zone 9 Alarm Code	19 ¹
18-19	Primary # Zone 10 Alarm Code	1A ¹
20-21	Primary # Zone 1 Disabled Code	41
22-23	Primary # Zone 2 Disabled Code	42
24-25	Primary # Zone 3 Disabled Code	43
26-27	Primary # Zone 4 Disabled Code	44
28-29	Primary # Zone 5 Disabled Code	45
30-31	Primary # Zone 6 Disabled Code	46
32-33	Primary # Zone 7 Disabled Code	47
34-35	Primary # Zone 8 Disabled Code	48
36-37	Primary # Zone 9 Disabled Code	49
38-39	Primary # Zone 10 Disabled Code	4A
40-41	Primary # Drill Code	97
42-43	Primary # AC Fault Code	92
44-45	Primary # Zone 1 Fault Code	F1
46-47	Primary # Zone 2 Fault Code	F2
48-49	Primary # Zone 3 Fault Code	F3
50-51	Primary # Zone 4 Fault Code	F4
52-53	Primary # Zone 5 Fault Code	F5
54-55	Primary # Zone 6 Fault Code	F6
56-57	Primary # Zone 7 Fault Code	F7
58-59	Primary # Zone 8 Fault Code	F8
60-61	Primary # Zone 9 Fault Code	F9
62-63	Primary # Zone 10 Fault Code	FA
64-65	Primary # Earth Fault Code	61
66-67	Primary # Low Battery Fault Code	62
68-69	Primary # No Battery Fault Code	63
70-71	Primary # Telco Primary Line Fault Code	64
72-73	Primary # Telco Secondary Line Fault Code	65
74-75	Primary # NAC #1 Fault Code	66
76-77	Primary # NAC #2 Fault Code	67
78-79	Primary # NAC #3 Fault Code	68
80-81	Primary # NAC #4 Fault Code	69
82-83	Primary # NAC #1 Disable Code	4B
84-85	Primary # NAC #2 Disable Code	4C
86-87	Primary # NAC #3 Disable Code	4D
88-89	Primary # NAC #4 Disable Code	4E
90-91	Primary # Comm Trouble Primary # Code	6A
92-93	Primary # Comm Trouble Secondary # Code	6B
94-95	Primary # Printer Fault Code	6C
96-97	Primary # Annunciator Fault Code	6D
98-99	Primary # 485 Comm Trouble Code	6E
100-101	Primary # System Off Normal Code	6F

TABLE 3-4: Event Codes, Primary Central Station Number

<u>Address</u>	<u>Description</u>	<u>Setting</u>
102-103	Primary # Zone 1 Alarm Restore Code	E1
104-105	Primary # Zone 2 Alarm Restore Code	E2
106-107	Primary # Zone 3 Alarm Restore Code	E3
108-109	Primary # Zone 4 Alarm Restore Code	E4
110-111	Primary # Zone 5 Alarm Restore Code	E5
112-113	Primary # Zone 6 Alarm Restore Code	E6
114-115	Primary # Zone 7 Alarm Restore Code	E7
116-117	Primary # Zone 8 Alarm Restore Code	E8
118-119	Primary # Zone 9 Alarm Restore Code	E9
120-121	Primary # Zone 10 Alarm Restore Code	EA
122-123	Primary # Zone 1 Disabled Restore Code	51
124-125	Primary # Zone 2 Disabled Restore Code	52
126-127	Primary # Zone 3 Disabled Restore Code	53
128-129	Primary # Zone 4 Disabled Restore Code	54
130-131	Primary # Zone 5 Disabled Restore Code	55
132-133	Primary # Zone 6 Disabled Restore Code	56
134-135	Primary # Zone 7 Disabled Restore Code	57
136-137	Primary # Zone 8 Disabled Restore Code	58
138-139	Primary # Zone 9 Disabled Restore Code	59
140-141	Primary # Zone 10 Disabled Restore Code	5A
142-143	Primary # Drill Restore Code	98
144-145	Primary # AC Fault Restore Code	93
146-147	Primary # Zone 1 Fault Restore Code	D1
148-149	Primary # Zone 2 Fault Restore Code	D2
150-151	Primary # Zone 3 Fault Restore Code	D3
152-153	Primary # Zone 4 Fault Restore Code	D4
154-155	Primary # Zone 5 Fault Restore Code	D5
156-157	Primary # Zone 6 Fault Restore Code	D6
158-159	Primary # Zone 7 Fault Restore Code	D7
160-161	Primary # Zone 8 Fault Restore Code	D8
162-163	Primary # Zone 9 Fault Restore Code	D9
164-165	Primary # Zone 10 Fault Restore Code	DA
166-167	Primary # Earth Fault Restore Code	A1
168-169	Primary #Low Battery Fault Restore Code	A2
170-171	Primary # No Battery Fault Restore Code	A3
172-173	Primary # Telco Primary Line Fault Restore Code	A4
174-175	Primary # Telco Secondary Line Fault Restore Code	A5
176-177	Primary # NAC #1 Fault Restore Code	A6
178-179	Primary # NAC #2 Fault Restore Code	A7
180-181	Primary # NAC #3 Fault Restore Code	A8
182-183	Primary # NAC #4 Fault Restore Code	A9
184-185	Primary # NAC #1 Disable Restore Code	5B
186-187	Primary # NAC #2 Disable Restore Code	5C
188-189	Primary # NAC #3 Disable Restore Code	5D
190-191	Primary # NAC #4 Disable Restore Code	5E
192-193	Primary # Comm Trouble Primary # Restore Code	AA
194-195	Primary # Comm Trouble Secondary # Restore Code	AB
196-197	Primary # Printer Fault Restore Code	AC
198-199	Primary # Annunciator Fault Restore Code	AD
200-201	Primary # 485 Comm Trouble Restore Code	AE
201-203	Primary # System Off Normal Restore Code	AF
204-205	Primary # System Test Report	99
206-207	Primary # System Abnormal Test Report	91
208-209	Primary # Request for Up/Download	71
210-211	Primary # Successful Upload	72
212-213	Primary # Successful Download	73
214-215	Primary # Failed Up/Download	74

1. Zones programmed as supervisory alarm transmit as 81, 82, 83, 84, 85, 86, 87, 88, 89, 8A (instead of 11, 12, 13, 14, 15, 16, 17, 18, 19, 1A).

Program Options

Ademco Contact ID Format

If 'E' is entered for address 16 in Program Mode Level 1, the data shown in Table 3-5 is automatically programmed for the Primary Central Station phone number event codes. Enter '000' for the setting to disable the report. The Setting entry is programmable, the Zone Number cannot be changed. Restoral code settings match the settings shown with the addition of an 'R' code transmitted. Refer to page 109 for additional information.

TABLE 3-5: Event Codes, Primary Central Station Number

<u>Address</u>	<u>Description</u>	<u>Setting</u>	<u>Zone No.</u>
0-2	Primary # Zone 1 Alarm Code	111 ¹	001
3-5	Primary # Zone 2 Alarm Code	111 ¹	002
6-8	Primary # Zone 3 Alarm Code	111 ¹	003
9-11	Primary # Zone 4 Alarm Code	111 ¹	004
12-14	Primary # Zone 5 Alarm Code	111 ¹	005
15-17	Primary # Zone 6 Alarm Code	111 ¹	006
18-20	Primary # Zone 7 Alarm Code	111 ¹	007
21-23	Primary # Zone 8 Alarm Code	111 ¹	008
24-26	Primary # Zone 9 Alarm Code	111 ¹	009
27-29	Primary # Zone 10 Alarm Code	111 ¹	010
30-32	Primary # Zone 1 Disabled Code	570	001
33-35	Primary # Zone 2 Disabled Code	570	002
36-38	Primary # Zone 3 Disabled Code	570	003
39-41	Primary # Zone 4 Disabled Code	570	004
42-44	Primary # Zone 5 Disabled Code	570	005
45-47	Primary # Zone 6 Disabled Code	570	006
48-50	Primary # Zone 7 Disabled Code	570	007
51-53	Primary # Zone 8 Disabled Code	570	008
54-56	Primary # Zone 9 Disabled Code	570	009
57-59	Primary # Zone 10 Disabled Code	570	010
60-62	Primary # Drill Code	604	000
63-65	Primary # AC Fault Code	301	000
66-68	Primary # Zone 1 Fault Code	380	001
69-71	Primary # Zone 2 Fault Code	380	002
72-74	Primary # Zone 3 Fault Code	380	003
75-77	Primary # Zone 4 Fault Code	380	004
78-80	Primary # Zone 5 Fault Code	380	005
81-83	Primary # Zone 6 Fault Code	380	006
84-86	Primary # Zone 7 Fault Code	380	007
87-89	Primary # Zone 8 Fault Code	380	008
90-92	Primary # Zone 9 Fault Code	380	009
93-95	Primary # Zone 10 Fault Code	380	010
96-98	Primary # Earth Fault Code	310	000
99-101	Primary # Low Battery Fault Code	302	000
102-104	Primary # No Battery Fault Code	311	000
105-107	Primary # Telco Primary Line Fault Code	351	000
108-110	Primary # Telco Secondary Line Fault Code	352	000
111-113	Primary # NAC #1 Fault Code	321	001
114-116	Primary # NAC #2 Fault Code	322	002
117-119	Primary # NAC #3 Fault Code	326	003
120-122	Primary # NAC #4 Fault Code	327	004
123-125	Primary # NAC #1 Disable Code	521	001
126-128	Primary # NAC #2 Disable Code	522	002
129-131	Primary # NAC #3 Disable Code	526	003
132-134	Primary # NAC #4 Disable Code	527	004
135-137	Primary # Comm Trouble Primary # Code	354	001
138-140	Primary # Comm Trouble Secondary # Code	354	002
141-143	Primary # Printer Fault Code	336	000
144-146	Primary # Annunciator Fault Code	330	001
147-149	Primary # 485 Comm Trouble Code	330	002
150-152	Primary # System Off Normal Code	308	000
153-155	Primary # System Test Message	602	000
156-158	Primary # System Abnormal Test Message	608	000
159-161	Primary # Upload/Download Request Code	411	000
162-164	Primary # Upload Successful Code	416	000
165-167	Primary # Download Successful Code	412	000
168-170	Primary # Upload/Download Failed Code	413	000

1. Refer to Table 3-1 for list of zone alarm event codes.

Program Options

3+1, 4+1 Express, 4+1 Standard and Expanded, 4+2 Expanded Formats

If '0, 2, 3, 4, 5, 6, 7, 8, 9, B or D' are entered for address 42 in Program Mode Level 1, the data shown in Table 3-6 is automatically programmed for the Secondary Central Station phone number event codes. Enter '0' for the setting to disable the report.

TABLE 3-6: Event Codes, Secondary Central Station Number

<u>Address</u>	<u>Description</u>	<u>Setting</u>
216	Secondary # Zone 1 Alarm Code	1 ¹
217	Secondary # Zone 2 Alarm Code	1 ¹
218	Secondary # Zone 3 Alarm Code	1 ¹
219	Secondary # Zone 4 Alarm Code	1 ¹
220	Secondary # Zone 5 Alarm Code	1 ¹
221	Secondary # Zone 6 Alarm Code	1 ¹
222	Secondary # Zone 7 Alarm Code	1 ¹
223	Secondary # Zone 8 Alarm Code	1 ¹
224	Secondary # Zone 9 Alarm Code	1 ¹
225	Secondary # Zone 10 Alarm Code	1 ¹
226	Secondary # Zone 1 Disabled Code	4
227	Secondary # Zone 2 Disabled Code	4
228	Secondary # Zone 3 Disabled Code	4
229	Secondary # Zone 4 Disabled Code	4
230	Secondary # Zone 5 Disabled Code	4
231	Secondary # Zone 6 Disabled Code	4
232	Secondary # Zone 7 Disabled Code	4
233	Secondary # Zone 8 Disabled Code	4
234	Secondary # Zone 9 Disabled Code	4
235	Secondary # Zone 10 Disabled Code	4
236	Secondary # Drill Code	9
237	Secondary # AC Fault Code	9
238	Secondary # Zone 1 Fault Code	F
239	Secondary # Zone 2 Fault Code	F
240	Secondary # Zone 3 Fault Code	F
241	Secondary # Zone 4 Fault Code	F
242	Secondary # Zone 5 Fault Code	F
243	Secondary # Zone 6 Fault Code	F
244	Secondary # Zone 7 Fault Code	F
245	Secondary # Zone 8 Fault Code	F
246	Secondary # Zone 9 Fault Code	F
247	Secondary # Zone 10 Fault Code	F
248	Secondary # Earth Fault Code	6
249	Secondary # Low Battery Fault Code	6
250	Secondary # No Battery Fault Code	6
251	Secondary # Telco Primary Line Fault Code	6
252	Secondary # Telco Secondary Line Fault Code	6
253	Secondary # NAC #1 Fault Code	6
254	Secondary # NAC #2 Fault Code	6
255	Secondary # NAC #3 Fault Code	6
256	Secondary # NAC #4 Fault Code	6
257	Secondary # NAC #1 Disable Code	4
258	Secondary # NAC #2 Disable Code	4
259	Secondary # NAC #3 Disable Code	4
260	Secondary # NAC #4 Disable Code	4
261	Secondary # Comm Trouble Primary # Code	6
262	Secondary # Comm Trouble Secondary # Code	6
263	Secondary # Printer Fault Code	6
264	Secondary # Annunciator Fault Code	6
265	Secondary # 485 Comm Trouble Code	6
266	Secondary # System Off Normal Code	6
267	Secondary # Zone 1 Alarm Restore Code	E

Program Options

TABLE 3-6: Event Codes, Secondary Central Station Number

<u>Address</u>	<u>Description</u>	<u>Setting</u>
268	Secondary # Zone 2 Alarm Restore Code	E
269	Secondary # Zone 3 Alarm Restore Code	E
270	Secondary # Zone 4 Alarm Restore Code	E
271	Secondary # Zone 5 Alarm Restore Code	E
272	Secondary # Zone 6 Alarm Restore Code	E
273	Secondary # Zone 7 Alarm Restore Code	E
274	Secondary # Zone 8 Alarm Restore Code	E
275	Secondary # Zone 9 Alarm Restore Code	E
276	Secondary # Zone 10 Alarm Restore Code	E
277	Secondary # Zone 1 Disabled Restore Code	5
278	Secondary # Zone 2 Disabled Restore Code	5
279	Secondary # Zone 3 Disabled Restore Code	5
280	Secondary # Zone 4 Disabled Restore Code	5
281	Secondary # Zone 5 Disabled Restore Code	5
282	Secondary # Zone 6 Disabled Restore Code	5
283	Secondary # Zone 7 Disabled Restore Code	5
284	Secondary # Zone 8 Disabled Restore Code	5
285	Secondary # Zone 9 Disabled Restore Code	5
286	Secondary # Zone 10 Disabled Restore Code	5
287	Secondary # Drill Restore Code	9
288	Secondary # AC Fault Restore Code	9
289	Secondary # Zone 1 Fault Restore Code	D
290	Secondary # Zone 2 Fault Restore Code	D
291	Secondary # Zone 3 Fault Restore Code	D
292	Secondary # Zone 4 Fault Restore Code	D
293	Secondary # Zone 5 Fault Restore Code	D
294	Secondary # Zone 6 Fault Restore Code	D
295	Secondary # Zone 7 Fault Restore Code	D
296	Secondary # Zone 8 Fault Restore Code	D
297	Secondary # Zone 9 Fault Restore Code	D
298	Secondary # Zone 10 Fault Restore Code	D
299	Secondary # Earth Fault Restore Code	A
300	Secondary #Low Battery Fault Restore Code	A
301	Secondary # No Battery Fault Restore Code	A
302	Secondary # Telco Primary Line Fault Restore Code	A
303	Secondary # Telco Secondary Line Fault Restore Code	A
304	Secondary # NAC #1 Fault Restore Code	A
305	Secondary # NAC #2 Fault Restore Code	A
306	Secondary # NAC #3 Fault Restore Code	A
307	Secondary # NAC #4 Fault Restore Code	A
308	Secondary # NAC #1 Disable Restore Code	5
309	Secondary # NAC #2 Disable Restore Code	5
310	Secondary # NAC #3 Disable Restore Code	5
311	Secondary # NAC #4 Disable Restore Code	5
312	Secondary # Comm Trouble Primary # Restore Code	A
313	Secondary # Comm Trouble Secondary # Restore Code	A
314	Secondary # Printer Fault Restore Code	A
315	Secondary # Annunciator Fault Restore Code	A
316	Secondary # 485 Comm Trouble Restore Code	A
317	Secondary # System Off Normal Restore Code	A
318	Secondary # System Test Report	9
319	Secondary # System Abnormal Test Report	F
320	Secondary # Request for Up/Download	7
321	Secondary # Successful Upload	7
322	Secondary # Successful Download	7
323	Secondary # Failed Up/Download	7

1. Zones programmed as supervisory alarm transmit as Code 8 instead of Code 1.

Program Options

4+2 Standard and 4+2 Express Formats

If '1, A or C' are entered for address 42 in Program Mode Level 1, the data shown in Table 3-7 is automatically programmed for the Secondary Central Station phone number event codes. Enter '00' for the setting to disable the report.

TABLE 3-7: Event Codes, Secondary Central Station Number

<u>Address</u>	<u>Description</u>	<u>Setting</u>
216-217	Secondary # Zone 1 Alarm Code	11 ¹
218-219	Secondary # Zone 2 Alarm Code	12 ¹
220-221	Secondary # Zone 3 Alarm Code	13 ¹
222-223	Secondary # Zone 4 Alarm Code	14 ¹
224-225	Secondary # Zone 5 Alarm Code	15 ¹
226-227	Secondary # Zone 6 Alarm Code	16 ¹
228-229	Secondary # Zone 7 Alarm Code	17 ¹
230-231	Secondary # Zone 8 Alarm Code	18 ¹
232-233	Secondary # Zone 9 Alarm Code	19 ¹
234-235	Secondary # Zone 10 Alarm Code	1A ¹
236-237	Secondary # Zone 1 Disabled Code	41
238-239	Secondary # Zone 2 Disabled Code	42
240-241	Secondary # Zone 3 Disabled Code	43
242-243	Secondary # Zone 4 Disabled Code	44
244-245	Secondary # Zone 5 Disabled Code	45
246-247	Secondary # Zone 6 Disabled Code	46
248-249	Secondary # Zone 7 Disabled Code	47
250-251	Secondary # Zone 8 Disabled Code	48
252-253	Secondary # Zone 9 Disabled Code	49
254-255	Secondary # Zone 10 Disabled Code	4A
256-257	Secondary # Drill Code	97
258-259	Secondary # AC Fault Code	92
260-261	Secondary # Zone 1 Fault Code	F1
262-263	Secondary # Zone 2 Fault Code	F2
264-265	Secondary # Zone 3 Fault Code	F3
266-267	Secondary # Zone 4 Fault Code	F4
268-269	Secondary # Zone 5 Fault Code	F5
270-271	Secondary # Zone 6 Fault Code	F6
272-273	Secondary # Zone 7 Fault Code	F7
274-275	Secondary # Zone 8 Fault Code	F8
276-277	Secondary # Zone 9 Fault Code	F9
278-279	Secondary # Zone 10 Fault Code	FA
280-281	Secondary # Earth Fault Code	61
282-283	Secondary # Low Battery Fault Code	62
284-285	Secondary # No Battery Fault Code	63
286-287	Secondary # Telco Primary Line Fault Code	64
288-289	Secondary # Telco Secondary Line Fault Code	65
290-291	Secondary # NAC #1 Fault Code	66
292-293	Secondary # NAC #2 Fault Code	67
294-295	Secondary # NAC #3 Fault Code	68
296-297	Secondary # NAC #4 Fault Code	69
298-299	Secondary # NAC #1 Disable Code	4B
300-301	Secondary # NAC #2 Disable Code	4C
302-303	Secondary # NAC #3 Disable Code	4D
304-305	Secondary # NAC #4 Disable Code	4E
306-307	Secondary # Comm Trouble Primary # Code	6A
308-309	Secondary # Comm Trouble Secondary # Code	6B
310-311	Secondary # Printer Fault Code	6C
312-313	Secondary # Annunciator Fault Code	6D
314-315	Secondary # 485 Comm Trouble Code	6E
316-317	Secondary # System Off Normal Code	6F
318-319	Secondary # Zone 1 Alarm Restore Code	E1

Program Options

TABLE 3-7: Event Codes, Secondary Central Station Number

<u>Address</u>	<u>Description</u>	<u>Setting</u>
320-321	Secondary # Zone 2 Alarm Restore Code	E2
322-323	Secondary # Zone 3 Alarm Restore Code	E3
324-325	Secondary # Zone 4 Alarm Restore Code	E4
326-327	Secondary # Zone 5 Alarm Restore Code	E5
328-329	Secondary # Zone 6 Alarm Restore Code	E6
330-331	Secondary # Zone 7 Alarm Restore Code	E7
332-333	Secondary # Zone 8 Alarm Restore Code	E8
334-335	Secondary # Zone 9 Alarm Restore Code	E9
336-337	Secondary # Zone 10 Alarm Restore Code	EA
338-339	Secondary # Zone 1 Disabled Restore Code	51
340-341	Secondary # Zone 2 Disabled Restore Code	52
342-343	Secondary # Zone 3 Disabled Restore Code	53
344-345	Secondary # Zone 4 Disabled Restore Code	54
346-347	Secondary # Zone 5 Disabled Restore Code	55
348-349	Secondary # Zone 6 Disabled Restore Code	56
350-351	Secondary # Zone 7 Disabled Restore Code	57
352-353	Secondary # Zone 8 Disabled Restore Code	58
354-355	Secondary # Zone 9 Disabled Restore Code	59
356-357	Secondary # Zone 10 Disabled Restore Code	5A
358-359	Secondary # Drill Restore Code	98
360-361	Secondary # AC Fault Restore Code	93
362-363	Secondary # Zone 1 Fault Restore Code	D1
364-365	Secondary # Zone 2 Fault Restore Code	D2
366-367	Secondary # Zone 3 Fault Restore Code	D3
368-369	Secondary # Zone 4 Fault Restore Code	D4
370-371	Secondary # Zone 5 Fault Restore Code	D5
372-373	Secondary # Zone 6 Fault Restore Code	D6
374-375	Secondary # Zone 7 Fault Restore Code	D7
376-377	Secondary # Zone 8 Fault Restore Code	D8
378-379	Secondary # Zone 9 Fault Restore Code	D9
380-381	Secondary # Zone 10 Fault Restore Code	DA
382-383	Secondary # Earth Fault Restore Code	A1
384-385	Secondary #Low Battery Fault Restore Code	A2
386-387	Secondary # No Battery Fault Restore Code	A3
388-389	Secondary # Telco Primary Line Fault Restore Code	A4
390-391	Secondary # Telco Secondary Line Fault Restore Code	A5
392-393	Secondary # NAC #1 Fault Restore Code	A6
394-395	Secondary # NAC #2 Fault Restore Code	A7
396-397	Secondary # NAC #3 Fault Restore Code	A8
398-399	Secondary # NAC #4 Fault Restore Code	A9
400-401	Secondary # NAC #1 Disable Restore Code	5B
402-403	Secondary # NAC #2 Disable Restore Code	5C
404-405	Secondary # NAC #3 Disable Restore Code	5D
406-407	Secondary # NAC #4 Disable Restore Code	5E
408-409	Secondary # Comm Trouble Primary # Restore Code	AA
410-411	Secondary # Comm Trouble Secondary # Restore Code	AB
412-413	Secondary # Printer Fault Restore Code	AC
414-415	Secondary # Annunciator Fault Restore Code	AD
416-417	Secondary # 485 Comm Trouble Restore Code	AE
418-419	Secondary # System Off Normal Restore Code	AF
420-421	Secondary # System Test Report	99
422-423	Secondary # System Abnormal Test Report	91
424-425	Secondary # Request for Up/Download	71
426-427	Secondary # Successful Upload	72
428-429	Secondary # Successful Download	73
430-431	Secondary # Failed Up/Download	74

1. Zones programmed as supervisory alarm transmit as 81, 82, 83, 84, 85, 86, 87, 88, 89, 8A.

Program Options

Ademco Contact ID Format

If 'E' is entered for address 42 in Program Mode Level 1, the data shown in Table 3-8 is automatically programmed for the Secondary Central Station phone number event codes. Enter '000' for the setting to disable the report. The Setting entry is programmable, the Zone Number cannot be changed. Restoral code settings match the settings shown with the addition of an 'R' code transmitted. Refer to page 99 for additional information.

TABLE 3-8: Event Codes, Secondary Central Station Number

<u>Address</u>	<u>Description</u>	<u>Setting</u>	<u>Zone No.</u>
216-218	Secondary # Zone 1 Alarm Code	111 ¹	001
219-221	Secondary # Zone 2 Alarm Code	111 ¹	002
222-224	Secondary # Zone 3 Alarm Code	111 ¹	003
225-227	Secondary # Zone 4 Alarm Code	111 ¹	004
228-230	Secondary # Zone 5 Alarm Code	111 ¹	005
231-233	Secondary # Zone 6 Alarm Code	111 ¹	006
234-236	Secondary # Zone 7 Alarm Code	111 ¹	007
237-239	Secondary # Zone 8 Alarm Code	111 ¹	008
240-242	Secondary # Zone 9 Alarm Code	111 ¹	009
243-245	Secondary # Zone 10 Alarm Code	111 ¹	010
246-248	Secondary # Zone 1 Disabled Code	570	001
249-251	Secondary # Zone 2 Disabled Code	570	002
252-254	Secondary # Zone 3 Disabled Code	570	003
255-257	Secondary # Zone 4 Disabled Code	570	004
258-260	Secondary # Zone 5 Disabled Code	570	005
261-263	Secondary # Zone 6 Disabled Code	570	006
264-266	Secondary # Zone 7 Disabled Code	570	007
267-269	Secondary # Zone 8 Disabled Code	570	008
270-272	Secondary # Zone 9 Disabled Code	570	009
273-275	Secondary # Zone 10 Disabled Code	570	010
276-278	Secondary # Drill Code	604	000
279-281	Secondary # AC Fault Code	301	000
282-284	Secondary # Zone 1 Fault Code	380	001
285-287	Secondary # Zone 2 Fault Code	380	002
288-290	Secondary # Zone 3 Fault Code	380	003
291-293	Secondary # Zone 4 Fault Code	380	004
294-296	Secondary # Zone 5 Fault Code	380	005
297-299	Secondary # Zone 6 Fault Code	380	006
300-302	Secondary # Zone 7 Fault Code	380	007
303-305	Secondary # Zone 8 Fault Code	380	008
306-308	Secondary # Zone 9 Fault Code	380	009
309-311	Secondary # Zone 10 Fault Code	380	010
312-314	Secondary # Earth Fault Code	310	000
315-317	Secondary # Low Battery Fault Code	302	000
318-320	Secondary # No Battery Fault Code	311	000
321-323	Secondary # Telco Primary Line Fault Code	351	000
324-326	Secondary # Telco Secondary Line Fault Code	352	000
327-329	Secondary # NAC #1 Fault Code	321	001
330-332	Secondary # NAC #2 Fault Code	322	002
333-335	Secondary # NAC #3 Fault Code	326	003
336-338	Secondary # NAC #4 Fault Code	327	004
339-341	Secondary # NAC #1 Disable Code	521	001
342-344	Secondary # NAC #2 Disable Code	522	002
345-347	Secondary # NAC #3 Disable Code	526	003
348-350	Secondary # NAC #4 Disable Code	527	004
351-353	Secondary # Comm Trouble Primary # Code	354	001
354-356	Secondary # Comm Trouble Secondary # Code	354	002
357-359	Secondary # Printer Fault Code	336	000
360-362	Secondary # Annunciator Fault Code	330	001
363-365	Secondary # 485 Comm Trouble Code	330	002
366-368	Secondary # System Off Normal Code	308	000
369-371	Secondary # System Test Message	602	000
372-374	Secondary # System Abnormal Test Message	608	000
375-377	Secondary # Upload/Download Request Code	411	000
378-380	Secondary # Upload Successful Code	416	000
381-383	Secondary # Download Successful Code	412	000
384-386	Secondary # Upload/Download Failed Code	413	000

1. Refer to Table 3-1 for a list of zone alarm event codes.

3.3.3 Level Three - Option Module Selections

Each option of the Program Mode is entered by keying in the program mode entry code (**7764**) and pressing the [ENTER/STORE] key.

- ☛ **7764** spells PROG on a Touch-Tone® phone

If an incorrect key is entered, reenter the proper 4-digit code before pressing the [ENTER/STORE] key.

You are allowed a pause of up to 10 seconds in between each number while entering the code. After pressing the [ENTER/STORE] key, the control panel will be in Program Mode and display **P__1**, with the '1' flashing. Press **3** on the keypad and then the [ENTER/STORE] key to choose the Option Module Selections. You are allowed up to ten minutes of idle time at this point before starting your programming, otherwise, the control panel will return to Normal Mode. You also have a maximum of 10 minutes between any keystroke. All entries made prior to the 10 minute time-out are valid and are stored.

Upon entering the Option Modules Selections in programming mode, the following will be displayed on the FACP 7-Segment Display.

00_0
(address)(data)

The first three locations on the left of the display represent the memory address **00_** of the first Option Module (CAC-10F Converter Card). The last location **0** (farthest right) represents the contents of memory address '00', which indicates that the card is not installed. To install the card, press '1' on the keypad. Use the **Up** and **Down Arrow** keys to increment to the next address or decrement to the previous address.

When desired changes have been completed, exit programming mode by pressing the **MODE** key, followed by the 4-digit code for an alternate mode and then the [ENTER/STORE] key. To enter a different Programming Level, press **MODE** and then press the [ENTER/STORE] key. The display will show **P__3** with the '3' flashing. Press the digit (1, 2 or 4) of the Programming Level to be accessed. During Program Mode, if no key is pressed within 10 minutes, the panel will revert to Normal Mode.

Following are the various option modules and their addresses.

CAC-10F Class A Converter Card (00)

The factory default entry of '0' in address 00 informs the FACP that there is no CAC-10F Class A Converter Card installed in the panel. When a CAC-10F is installed, '1' must be entered for this address.

LED-10IM EIA-485 Interface Module (01)

The factory default entry of '0' indicates to the panel that an LED-10IM is not installed. Enter a '1' in address 01 if an LED-10IM EIA-485 Interface Module is installed.

Annunciator Maximum Monitored Address (02-03)

Annunciator addresses may be set from a value of '01' through '32'. Enter the value of the highest or maximum address value selected on any annunciator or ACM-8RF connected to the EIA-485 port off of the LED-10IM.

Devices which may be connected to the EIA-485 port include LDM graphic annunciators, ACS LED type annunciators, LED-10 Series annunciators and ACM-8RF relay modules. Included on the LDM, LED-10 Series and ACM-8RF are switches which select an address from 01 to 32. For each device added or connected to the EIA-485 port via the LED-10IM, select an address *on each*, with the exception of the ACM-8RF (refer to the applications section of the ACM-8RF Manual). Addresses must be sequential with no gaps allowed. For example, if 13 devices are connected to the EIA-845 port, the maximum monitored address value entered into locations 02-03 must be 02 = '1' and 03 = '3'. If 25 devices are connected to the EIA-485 port, the maximum monitored address entered into locations 02-03 must be 02 = '2' and 03 = '5'.

All devices connected to the EIA-485 are fully supervised by the FACP. Note that AFM annunciators occupy address '01'. The address of these annunciators cannot be altered. When using AFM devices with ACS series annunciators, LDMs, LED-10 Series and ACM-8RFs, be certain that none of the other devices are set to address '01'. *Factory default entry is 02 = 0 and 03 = 1.*

Program Options

Printer Installed (04)

The factory default entry of '0' in address 04 informs the FACP that a printer is not connected to the panel. This entry must be changed to '1' if a printer is connected. The PRT-24 printer interface module must be installed on J4 of the MS-5210UD main circuit board before a printer can be installed.

Printer Baud Rate (05)

Address 05 is used to set the Baud Rate when a printer is connected to the MS-5210UD. The factory default entry is '0' for 2400 Baud. Enter '1' for 4800 Baud or '2' for 9600 Baud. An entry in address 05 is valid only if a printer has been enabled in address 04.

NAC/Relay Option Module (06)

A Notification Appliance Circuit/Relay Option (NAC-REM) Module is available which adds two Style Z (Class A) NAC circuits (NACs 3 and 4) and two programmable Form-C relays (Relays 3 and 4). The factory default setting for address 06 is '0' for no module installed. This entry must be changed to '1' if the NAC/Relay module is installed.

Programmable Relay 3 Definition (07)

This address programs Relay 3 if the NAC/Relay Option Module has been enabled in address 06. The factory default entry for Relay 3 is '1' for supervisory. Enter '0' for alarm; '2' for supervisory autoresettable; '3' for trouble; '4' for communication fail; '5' for process monitoring; '6' for autoresettable process monitoring.

Programmable Relay 4 Definition (08)

This address programs Relay 4 if the NAC/Relay Option Module has been enabled in address 06. The factory default entry for Relay 4 is '4' for communication fail. Enter '0' for alarm; '1' for supervisory; '2' for supervisory autoresettable; '3' for trouble; '5' for process monitoring; '6' for autoresettable process monitoring.

NAC #3 Type Selection (09)

This address programs NAC #3 if the NAC/Relay Option Module has been enabled in address 06. The factory default entry for NAC #3 is '0' for enabled and silenceable. Enter '1' for enabled and nonsilenceable or '2' for disabled.

NAC #3 Silence Inhibit (10)

This address is used for the silence inhibit feature on NAC #3 if the NAC/Relay Option Module has been enabled in address 06. The factory default entry for NAC #3 is '0' for no silence inhibit. Enter '1' to enable the silence inhibit feature for NAC #3. This will prevent the silencing of NAC #3 for one minute following activation of an alarm.

NAC #3 Autosilence (11)

This address is used for the autosilence feature on NAC #3 if the NAC/Relay Option Module has been enabled in address 06. The factory default entry for NAC #3 is '0' for no autosilence. If you wish NAC #3 to be automatically silenced after one of the following lengths of time (requires prior approval of Local AHJ), enter '1' for 5 minutes; '2' for 10 minutes; '3' for 15 minutes; '4' for 20 minutes; '5' for 25 minutes; or '6' for 30 minutes.

NAC #3 Signal Coding (12)

This address is used to select coding for NAC #3 if the NAC/Relay Option Module has been enabled in address 06. The factory default entry for NAC #3 is '0' for steady output (no coding). Enter '1' for March Time coding (120 ppm); '2' for California Time coding (10 secs. On, 5 secs. Off); or '3' for Temporal Time coding (½ sec. On, ½ sec. Off, ½ sec. On, ½ sec. Off, ½ sec. On, 1½ secs. Off, and then repeat sequence).

NAC #4 Type Selection (13)

This address programs NAC #4 if the NAC/Relay Option Module has been enabled in address 06. The factory default entry for NAC #4 is '0' for enabled and silenceable. Enter '1' for enabled and nonsilenceable or '2' for disabled.

Program Options

NAC #4 Silence Inhibit (14)

This address is used for the silence inhibit feature on NAC #4 if the NAC/Relay Option Module has been enabled in address 06. The factory default entry for NAC #4 is '0' for no silence inhibit. Enter '1' to enable the silence inhibit feature for NAC #4. This will prevent the silencing of NAC #4 for one minute following activation of an alarm.

NAC #4 Autosilence (15)

This address is used for the autosilence feature on NAC #4 if the NAC/Relay Option Module has been enabled in address 06. The factory default entry for NAC #4 is '0' for no autosilence. If you wish NAC #4 to be automatically silenced after one of the following lengths of time (requires prior approval of Local AHJ), enter '1' for 5 minutes; '2' for 10 minutes; '3' for 15 minutes; '4' for 20 minutes; '5' for 25 minutes; or '6' for 30 minutes.

NAC #4 Signal Coding (16)

This address is used to select coding for NAC #4 if the NAC/Relay Option Module has been enabled in address 06. The factory default entry for NAC #4 is '0' for steady output (no coding). Enter '1' for March Time coding (120 ppm); '2' for California Time coding (10 secs. On, 5 secs. Off); or '3' for Temporal Time coding (½ sec. On, ½ sec. Off, ½ sec. On, ½ sec. Off, ½ sec. On, 1½ secs. Off, and then repeat sequence).

Supervisory Annunciation (17)

This address, when programmed to a '1', causes the annunciators (LDM, AFM, LED-10 Series) to indicate a supervisory alarm by turning on the appropriate yellow zone LED *only*. The yellow zone LED blinks at a ½ second ON/½ second OFF rate in alarm. It blinks at a 1 second ON/1 second OFF rate if the supervisory zone is in fault. Should both an alarm and a fault occur on a supervisory zone at the same time, the alarm takes priority and the blink rate is ½ second ON/½ second OFF.

The non-supervisory function will turn on the red zone alarm LED for any type of zone function. The blink rate at the annunciators is 1 second ON/1 second OFF for fire alarm, ½ second ON/½ second OFF for supervisory alarm and ¼ second ON/¼ second OFF for process monitored alarm. The default entry is '0' for non-supervisory annunciation. Enter '1' for Supervisory Annunciation.

Note: UL requires slide-in labels on all annunciators to be clearly marked as to the function of each zone.

CAUTION: When selecting this function, be aware that ACM-8RF relays programmed for alarm will not activate for supervisory alarms.



3.3.4 Level Four - Upload/Download Option

Each option of the Program Mode is entered by keying in the program mode entry code (**7764**) and pressing the [ENTER/STORE] key.

☛ **7764** spells PROG on a Touch-Tone® phone

If an incorrect key is entered, reenter the proper 4-digit code before pressing the [ENTER/STORE] key.

You are allowed a pause of up to 10 seconds in between each number while entering the code. After pressing the [ENTER/STORE] key, the control panel will be in Program Mode and display **P__1**, with the '1' flashing. Press **4** on the keypad and then the [ENTER/STORE] key to choose the Upload/Download Option. You are allowed up to ten minutes of idle time at this point before starting your programming, otherwise, the control panel will return to Normal Mode. You also have a maximum of 10 minutes between any key stroke. All entries made prior to the 10 minute time-out are valid and are stored.

Program Options

Upon entering the Upload/Download Option in programming mode, the following will be displayed on the FACP LCD.

00_0
(address)(data)

The first three locations on the left of the display represent the memory address **00**. The last location **0** (farthest right) represents the contents of memory address 00 which is the first digit of the Panel Identification Number. To change the Panel ID Number, key in the first of the four digits for the ID. Increment to the next address and key in the second number. Continue until all digits are programmed. Use the **Up** and **Down Arrow** keys to increment to the next address or decrement to the previous address.

When desired changes have been completed, exit programming mode by pressing the **MODE** key, followed by the 4-digit code for an alternate mode and then the **[ENTER/STORE]** key. To enter a different Programming Level, press **MODE** and then press the **[ENTER/STORE]** key. The display will show **P__4** with the '4' flashing. Press the digit (1, 2 or 3) of the Programming Level to be accessed. During Program Mode, if no key is pressed within 10 minutes, the panel will revert to Normal Mode.

The MS-5210UD can be programmed remotely from a PC using a modem and the telephone line. Information can also be retrieved from the FACP with the same method. The Upload/Download Option allows an operator to set the necessary parameters to allow the uploading and downloading of data between the FACP and PC.

Following are the various parameters and their addresses.

Panel Identification Number (00-03)

The Panel Identification Number is a 4-digit code (valid digits being 0-F) that is used to identify the installed panel. This code is separate from the 8-digit secret code loaded in by the Service Terminal. It is important to program this 4-digit code at the job site the first time that downloading is performed so that the called Service Terminal can identify the control panel. Factory default is '0000'. (Future use).

Service Terminal Number 1 Phone Number (04-19)

Addresses 04 through 19 are reserved for the Service Terminal Number 1 phone number. Factory default is all Fs. Valid entries are 0-9 plus A, B, C, D and E. Use 'F' to designate the end of the phone number.

Ring Count on Primary Phone Line (20-21)

Use this address to designate the number of rings allowed on the primary phone line prior to answering an incoming call from a Service Terminal. Factory default is **25** meaning the panel will not answer an incoming call until 25 rings are detected. This entry may be programmed up to a maximum of **25** rings. A setting of **00** prevents the panel from answering incoming calls.

FAX/Answer Machine, Primary Phone Line (22)

This entry is used when the primary phone line is being shared with a FAX, answering machine or other device. Factory default is '0', no sharing of the primary phone line. An entry of '1' indicates that another device is sharing the primary phone line. The panel will wait for three consecutive calls from the Service Terminal spaced 30 seconds apart, before responding.

Service Terminal Number 2 Phone Number (23-38)

Addresses 23 through 38 are reserved for the Service Terminal Number 2 phone number. Factory default is all Fs. Valid entries are 0-9 plus A, B, C, D and E. Use 'F' to designate the end of the phone number.

Ring Count on Secondary Phone Line (39-40)

Use this address to designate the number of rings allowed on the secondary phone line prior to answering an incoming call from a Service Terminal. Factory default is **25**, meaning the panel will not answer an incoming call until 25 rings are detected. This entry affects the secondary phone line only. This entry may be programmed up to a maximum of **25** rings. A setting of **00** prevents the panel from answering incoming calls.

Program Options

FAX/Answer Machine, Secondary Phone Line (41)

Factory default is '0' for no sharing of the secondary phone line with a FAX, answering machine or other device. An entry of '1' allows the panel to wait for three consecutive calls spaced 30 seconds apart from the Service Terminal before responding.

Upload/Download Reports Sent to Secondary Central Station Phone #, Backup or Always (42)

Leaving address 42 = 0 means that reports for request for 'upload/download', 'successful upload', 'successful download' and 'failed upload/download' will be sent to the secondary Central Station phone number only if attempts to the primary Central Station phone number are unsuccessful. Programming a '1' causes all reports to be transmitted to both primary and secondary phone numbers. Factory default is '0' for secondary backup only. Enter '1' to transmit to both Central Station phone numbers. Enter '2' to transmit to the first available receiver.



CAUTION: Do not alter entry while the communicator is active.

3.3.5 Default Programming

To return all program entries in all four levels to their factory original settings, perform the following steps only when the system is idle in Normal standby condition:

Press the **MODE** key followed by the 4-digit code **3337** and press the **[ENTER/STORE]** key.

☛ **3337** spells DEFP (**DEF**ault **P**rogramming) on a Touch-Tone® phone.

If an incorrect key is entered, reenter the proper 4-digit code before pressing the **[ENTER/STORE]** key.

Within five seconds, repeat this entry by again pressing the **MODE** key followed by the 4-digit code **3337** and pressing the **[ENTER/STORE]** key. The display will read **3337** while the E² nonvolatile memory (storage area for all programming options) is being reprogrammed with the original default settings. When reprogramming is complete, the display will be blank.

CHAPTER 4 *Operating Instructions*

FIGURE 4-1: New and Old Keypad/Display

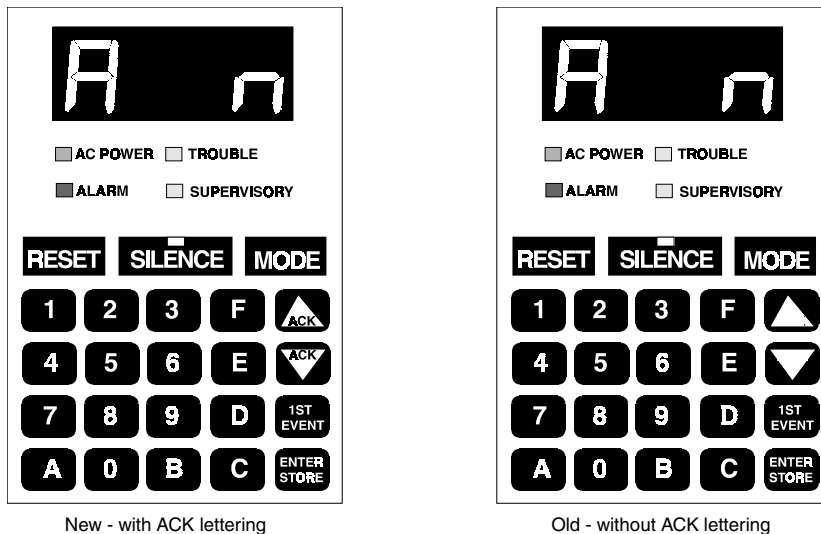

The MS-5210UD has several modes of operation including Normal, Program, Walk Test, Troubleshoot, History, Lamp Test, Print and Upload/Download. There are also four function modes which include Drill, Zone Enable/Disable, NAC Enable/Disable and Default Programming. *Upon initial power-up, the system will be in Normal Mode. This section discusses operation of the control panel in the **Normal Mode**.*

4.1 Switch Functions in Normal Mode

RESET

The System Reset switches reset the system and any smoke detectors. Reset switches may be located on the FACP keypad (illustrated in Figure 4-1), any of the ten zones programmed as a remote reset switch, remotely on any of the LED-10 Series annunciators, the LDM graphic annunciators, or the AFM series annunciators. If any of the System Reset Switches are pressed, the control panel will:

- ✓ Clear the display and status LEDs
- ✓ Turn off the Notification Appliance Circuits
- ✓ Reset all zones by temporarily removing power
- ✓ Silence the onboard piezo sounder
- ✓ Store 'reset' message in the History file
- ✓ Restore all system relays to normal
- ✓ Temporarily remove power from the resettable power output TB2 Terminals 3 and 4
- ✓ Output 'reset' message to printer

Any alarm, supervisory or trouble condition that exists after a system reset, will resound the system, reactivating normal system activity. Upon release of a System Reset Switch, the FACP display will read **rES_** for 6 seconds.

SILENCE

Silence switches may be located on the FACP keypad (illustrated in Figure 4-1), any of the ten zones programmed as a remote silence switch, remotely located on any of the LED-10 Series annunciators, the LDM graphic annunciators, or the AFM series annunciators. The Silence Switch performs the same functions as the System Acknowledge switch. In addition, if any of the System Silence switches are pressed, the following will occur:

- ✓ The silenceable Notification Appliance Circuits will be turned OFF
- ✓ The main circuit board silence LED will be turned ON
- ✓ The **SILn** message will be displayed (where **n** = NAC #)
- ✓ The system piezo sounders will be shut OFF
- ✓ 'NAC #N Silenced' message will be stored in the History file
- ✓ 'NAC #N Silenced' message will be sent to the printer

Upon the occurrence of a subsequent event (alarm or trouble), System Silence is overridden and the control panel will respond to the new event. *The System Silence switches will be ignored for nonsilenceable waterflow type alarms.*

ACKNOWLEDGE/STEP

Acknowledge/Step switches (Up/Down arrow keys) are located on newer model FACP keypads (refer to Figure 4-1), remotely located on any of the LED-10 Series annunciators, the LDM graphic annunciators, or the AFM series annunciators and an option exists that allows any of the ten zones to be programmed to function as a remote Acknowledge switch.

The Acknowledge/Step switch silences the system piezo sounders and changes all flashing system LEDs to steady. An acknowledge message is sent to the printer and history files. The Step function permits scrolling through multiple stored events during normal, history and walktest modes.

When more than one event exists, the first press of the Acknowledge/Step switch silences the system piezo sounders and changes all flashing system LEDs to steady. The second press of the switch stops the scrolling and holds the event on the display for five seconds. Subsequent pressing of the switch 'steps' through each active event. The Acknowledge/Step switch must be pressed within 15 seconds to prevent NACs from turning on if alarm presignal is selected. For additional information on alarm presignal, refer to "Programming Instructions" on page 39.

Note: Software P/N: MS-52102.0 or greater supports the Acknowledge key function at the FACP keypad.

DRILL

Drill switches may be located on any of the ten zones programmed as a remote drill switch, remotely on any of the LED-10 Series annunciators, the LDM graphic annunciators, or the AFM series annunciators. To perform a drill from any of these switches, the Drill switch must be pressed and held for two seconds (time to prevent accidental activation). The MS-5210UD turns on all NACs and turns off the system silence LEDs. The message shown on the display is **drill**. The drill message is sent to the printer and history files. The system silence keys will silence all silenceable NACs during a fire drill.

To perform a drill from the FACP, press the **MODE** key followed by the code **3745** then press **[ENTER/STORE]**. The display will read **drill**. The alarm relay is not activated. There is an option to transmit the fire drill report code to the Central Station. During a fire drill, the **SILENCE** key will silence all silenceable NACs and the **RESET** key restores the panel to normal. All zones remain active during a fire drill.

MODE

Pressing the Mode switch followed by a valid 4-digit numerical code and **[ENTER/STORE]** selects one of the six modes of operation.

To enter Normal Mode from any other mode press **MODE** then **6676 [ENTER/STORE]**.

- ☛ **6676** spells NORM on a Touch-Tone® phone.

1st EVENT

The 1st Event switch along with the Up Arrow and Down Arrow keys, are used to display any **presently** active alarm and/or fault conditions present in the system. Press the 1st Event switch at any time to display the first event (alarm and/or trouble) that occurred.

LED Display and Status LEDs

DOWN ARROW (ACK)

Use the Down Arrow key to view other events (older) that have occurred and are active (not yet cleared). It also acknowledges the event by silencing the local piezo sounder.

UP ARROW (ACK)

Use the Up Arrow key to view other events (newer) that have occurred and are active (not yet cleared). It also acknowledges the event by silencing the local piezo sounder.

[ENTER/STORE]

Refer to the individual mode descriptions in previous sections of this manual. In Normal Mode, this key is used after pressing the **MODE** key followed by a 4-digit mode code followed by the [ENTER/STORE] key.

4.2 LED Display and Status LEDs

LED Display

Four 7-Segment red LED characters provide visual annunciation of status, events and messages. A list of messages that may appear on the display in Normal Mode is shown below:

d_1	Zone 1 Disabled	F_9	Trouble Zone 9
d_2	Zone 2 Disabled	F_10	Trouble Zone 10
d_3	Zone 3 Disabled	F_85	Annunciator Bus Fault
d_4	Zone 4 Disabled	F_A	Annunciator Fault
d_5	Zone 5 Disabled	F_E	Earth Fault
d_6	Zone 6 Disabled	F_P	Printer Fault
d_7	Zone 7 Disabled	Lo_b	Low Battery
d_8	Zone 8 Disabled	no_b	No Battery
d_9	Zone 9 Disabled	PH_1	Primary C.S. No. Comm. Fault
d_10	Zone 10 Disabled	PH_2	Secondary C.S. No. Comm. Fault
d_b1	NAC/Bell #1 Disabled	bEL1	Bell 1 Fault
d_b2	NAC/Bell #2 Disabled	bEL2	Bell 2 Fault
d_b3	NAC/Bell #3 Disabled	bEL3	Bell 3 Fault
d_b4	NAC/Bell #4 Disabled	bEL4	Bell 4 Fault
drLL	Fire Drill	no_1	Primary Phone Line Fault
E_1	Zone 1 Enabled	no_2	Secondary Phone Line Fault
E_2	Zone 2 Enabled	PA_1	Process Monitoring Alarm Zone 1
E_3	Zone 3 Enabled	PA_2	Process Monitoring Alarm Zone 2
E_4	Zone 4 Enabled	PA_3	Process Monitoring Alarm Zone 3
E_5	Zone 5 Enabled	PA_4	Process Monitoring Alarm Zone 4
E_6	Zone 6 Enabled	PA_5	Process Monitoring Alarm Zone 5
E_7	Zone 7 Enabled	PA_6	Process Monitoring Alarm Zone 6
E_8	Zone 8 Enabled	PA_7	Process Monitoring Alarm Zone 7
E_9	Zone 9 Enabled	PA_8	Process Monitoring Alarm Zone 8
E_10	Zone 10 Enabled	PA_9	Process Monitoring Alarm Zone 9
A_1	Alarm Zone 1	PA10	Process Monitoring Alarm Zone 10
A_2	Alarm Zone 2	SIL1	NAC/Bell #1 Silenced
A_3	Alarm Zone 3	SIL2	NAC/Bell #2 Silenced
A_4	Alarm Zone 4	SIL3	NAC/Bell #3 Silenced
A_5	Alarm Zone 5	SIL4	NAC/Bell #4 Silenced
A_6	Alarm Zone 6	SU_1	Supervisory Alarm Zone 1
A_7	Alarm Zone 7	SU_2	Supervisory Alarm Zone 2
A_8	Alarm Zone 8	SU_3	Supervisory Alarm Zone 3
A_9	Alarm Zone 9	SU_4	Supervisory Alarm Zone 4
A_10	Alarm Zone 10	SU_5	Supervisory Alarm Zone 5
F_1	Trouble Zone 1	SU_6	Supervisory Alarm Zone 6
F_2	Trouble Zone 2	SU_7	Supervisory Alarm Zone 7
F_3	Trouble Zone 3	SU_8	Supervisory Alarm Zone 8
F_4	Trouble Zone 4	SU_9	Supervisory Alarm Zone 9
F_5	Trouble Zone 5	SU10	Supervisory Alarm Zone 10
F_6	Trouble Zone 6	_AC_	AC Power Loss
F_7	Trouble Zone 7	rES_	System Reset
F_8	Trouble Zone 8		

LED Display and Status LEDs

System Fire Alarm LED

A red LED that flashes when a fire alarm condition is detected during the alarm presignal period. It turns on steady when the system silence or acknowledge switches are pressed.

System Trouble LED

A yellow LED that blinks to indicate that a fault or abnormal condition exists and that the fire alarm system may be inoperative. It turns on steady when a system silence or acknowledge switch is pressed.

AC Power On LED

A green LED that remains on while the AC power supply is within correct limits. *If this indicator fails to light under normal conditions, service the system immediately.*

Supervisory LED

A yellow LED that blinks to indicate the need for action in connection with the supervision or maintenance of sprinklers, extinguishing systems or other protective systems.

System Silence LED

A yellow LED that turns on to indicate that an Alarm or Trouble condition exists in the system, but Notification Appliance Circuits (if programmed as silenceable) and local piezo sounder have been silenced.

Primary Line Active LED

A red LED that indicates the primary phone line is active.

Secondary Line Active LED

A red LED that indicates the secondary phone line is active.

Kiss-Off LED

A green LED that blinks when a Central Station has acknowledged receipt of each transmitted message or when a portion of up or download data has been accepted from a Service Terminal.

Modem LED

A green LED that stays on steady during modem types of communications.

FIGURE 4-2: Phone Connectors and LEDs

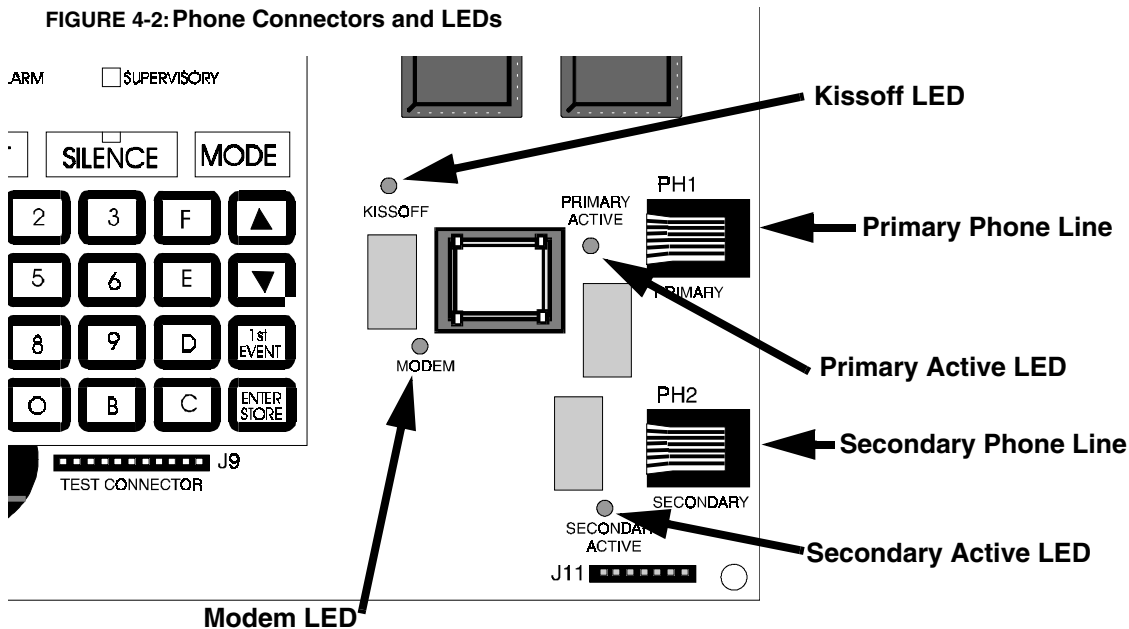

4.3 Operation

Normal Mode is the standard mode of operation. In this mode, the panel continuously monitors system status. When no alarm or trouble conditions exist, the display will be blank and all LEDs will be off (except the AC Power LED). The Notification Appliance Circuits will be off, all relays are in their normal state, the onboard piezo sounder will be off and the printer (if connected) will not be printing. The Primary and Secondary Phone Line Active LEDs are off since the communicator is not active.

All alarm and system trouble conditions are annunciated on the control panel's display. The control panel will maintain an 'active event list' which will consist of all alarms, supervisory alarms and system troubles currently active and not cleared, requiring immediate service. When the system is cleared and restored to normal, the display will be blank. All alarms and troubles are stored in a history file and may be recalled at any time.

Higher priority events take precedence over lower priority events. Display and reporting of System Status is done on a priority basis. Priorities are, from highest to lowest:

1. Alarms
2. Supervisory Alarms
3. System Troubles
4. Process Monitoring Alarms

If the events to be displayed consist of alarms and disabled zones only (no troubles), the control panel will scroll them on the display. As each new alarm occurs, it will be displayed immediately on the display for five seconds. After this five second period, the display will scroll all alarms in the system. Pressing the 1st Event key or one of the 'ACK' keys will stop the scrolling. The 1st Event key will also cause the display to show the *First* alarm that occurred after the panel was last reset, cleared of all active events and placed into normal mode. Operation of the Up and Down arrow keys will display all remaining events in sequence.

If events to be displayed include system troubles, only one event is displayed at a time and there is no scrolling. The event displayed is the highest priority. Pressing the 1st Event key will cause the display of the first event that occurred after the panel was last reset, cleared of all active events and placed into normal mode. Operation of the Up and Down arrow keys will display all remaining events in order of their occurrences.

4.3.1 Fire Alarm Response

The control panel will, upon detection of an alarm condition, cause the following:

- Blink the FACP alarm LED (1 second On, 1 second Off)
- Display the alarm message (i.e. **A__1** Alarm on Zone 1)
- Communicate the alarm to the Central Station
- Store the alarm in the History File
- Turn the Notification Appliance Circuits on
- Turn the piezo sounder on steady
- Turn on appropriate zone relay output (ACM-8RF)
- Turn on any system relays (main circuit board) programmed for alarm activation
- Output alarm message to printer
- Terminate upload or download communications
- Blink all remote annunciator general alarm LEDs (1 second On, 1 second Off)
- Blink all remote annunciator zone alarm LEDs (1 second On, 1 second Off)

Note that when any zone is programmed as a supervisory or process monitored zone, it will not be processed in the same manner as a conventional alarm zone. Refer to "*System Supervisory Condition Response*" on page 70 and "*Process Monitored Alarm Response*" on page 72.

4.3.2 Fire Alarm Restoral

The control panel returns to normal after all alarms have been cleared and a system reset switch has been pressed (pull stations have been reset, smoke detectors have reset and no smoke is present, waterflow has stopped). The control panel will perform the following upon restoral of all active alarms:

- Turn off the FACP alarm LED
- Clear the 4-character display
- Send all 'Zone Restoral' messages to the Central Station
- Turn off the Notification Appliance Circuits
- Turn off the piezo sounder
- Turn off appropriate zone relay output (ACM-8RF)
- Turn off any system relays (main circuit board) programmed for alarm activation
- Output alarm restoral message to printer
- Terminate upload or download communications
- Turn off all remote annunciator general alarm LEDs
- Turn off all remote annunciator zone alarm LEDs

4.3.3 System Supervisory Condition Response

Program zones for Supervisory in applications where a waterflow sensing device has been employed and the wiring to the waterflow valve and/or a tamper switch is to be monitored. If the tamper switch has been activated (Normally Open contacts close), a supervisory alarm condition will occur.

When a supervisory condition occurs, the control panel will cause the following:

- Blink the FACP supervisory LED (½ second On, ½ second Off)
- Display the following message: SUXX (XX=Zone Number)
- Communicate the supervisory condition to the Central Station
- Store the 'supervisory' message in the History File
- Pulse system piezo sounders (½ second On, ½ second Off)
- Turn on appropriate zone relay output (ACM-8RF)
- Turn on any system relays (main circuit board) programmed for supervisory activation
- Output system supervisory message to printer
- Terminate upload or download communications
- Blink all remote annunciator general supervisory alarm LEDs (½ second On, ½ second Off)
- Blink all remote annunciator zone supervisory alarm LEDs (½ second On, ½ second Off)

4.3.4 System Supervisory Restoral Response

When the supervisory condition has been cleared (condition is restored and the reset switch has been pressed), the control panel will perform the following:

- Turn off the supervisory LED
- Clear the display of the 'SUXX'
- Communicate a supervisory restoral message to the Central Station
- Shut off system piezo sounders
- Turn off appropriate zone relay output (ACM-8RF)
- Turn off any system relays (main circuit board) programmed for supervisory activation
- Output system supervisory restoral message to printer
- Terminate upload or download communications
- Turn off all remote annunciator general supervisory alarm LEDs
- Turn off all remote annunciator zone supervisory alarm LEDs

Note that for any zone programmed for Supervisory autoresettable, the Reset key does not need to be pressed to clear the zone (supervisory condition).

4.3.5 Trouble Condition Response

The control panel will perform the following upon detection of one or more trouble conditions:

- Blink the FACP trouble LED (1 second On, 1 second Off)
- Blink all annunciator general system trouble LEDs
- Blink all affected zone trouble LEDs on all system annunciators
- Activate any FACP trouble relay(s) if programmed for trouble activation
- Display the appropriate trouble message(s) in priority fashion from the highest priority to the lowest. *Note that the Up arrow key, Down arrow key or 1st Event key must be pressed to view the messages.*
- Communicate the trouble conditions to the Central Station
- Store the trouble conditions in the History File
- Sound system piezo sounders at a rate of 1 second On, 1 second Off
- Output the system trouble messages to the printer
- Terminate upload or download communications

Note that when AC Brownout occurs, the AC LED is turned off and the Trouble LED blinks. Should the brownout condition remain, it will be transmitted to the Central Station after a delay (see Program Address 77 in the Level 1 Main Panel Options section).

Possible trouble messages that may appear on the display are as follows:

<u>AC</u>	AC Loss (shown only when requested)	
d_1	Zone 1 Disabled	F_10 Trouble Zone 10
d_2	Zone 2 Disabled	d_b1 Bell 1 Disabled
d_3	Zone 3 Disabled	d_b2 Bell 2 Disabled
d_4	Zone 4 Disabled	d_b3 Bell 3 Disabled
d_5	Zone 5 Disabled	d_b4 Bell 4 Disabled
d_6	Zone 6 Disabled	F_A Annunciator Fault
d_7	Zone 7 Disabled	F_P Printer Fault
d_8	Zone 8 Disabled	F_E Earth Fault
d_9	Zone 9 Disabled	Lo_b Low Battery
d_10	Zone 10 Disabled	no_b No Battery
F_1	Trouble Zone 1	PH_1 Primary C.S. No. Comm. Fault
F_2	Trouble Zone 2	PH_2 Secondary C.S. No. Comm. Fault
F_3	Trouble Zone 3	bEL1 Bell 1 Fault
F_4	Trouble Zone 4	bEL2 Bell 2 Fault
F_5	Trouble Zone 5	bEL3 Bell 3 Fault
F_6	Trouble Zone 6	bEL4 Bell 4 Fault
F_7	Trouble Zone 7	no_1 Primary Phone Line Fault
F_8	Trouble Zone 8	no_2 Secondary Phone Line Fault
F_9	Trouble Zone 9	

4.3.6 Trouble Condition Restoral

The control panel performs the following upon restoral of all trouble conditions:

- The trouble LED is shut Off
- FACP trouble relay(s) deactivate if programmed for trouble activation
- If the trouble was loss of AC power, the control panel will turn on the AC LED upon restoral
- Clear the FACP display of trouble message(s)
- Communicate the restored trouble condition(s) to the Central Station
- Output the system trouble restoral message to the printer
- Terminate upload or download communications
- Turn off the system general trouble LED on all system annunciators if all trouble conditions are cleared
- Turn off all affected zone trouble LEDs on all system annunciators

4.3.7 Process Monitored Alarm Response

Upon detection of a critical or noncritical process monitored alarm condition on any zone, the control panel will:

- Display the alarm message **PAXX** (where XX = zone number)
- Communicate the alarm code programmed for the activated zone
- Store the alarm in the History File
- Pulse the piezo sounder at a ¼ second On, ¼ second Off
- Turn on appropriate zone relay output (ACM-8RF)
- Turn on any system relays (main circuit board) programmed for process alarm activation
- Output alarm message to printer
- Terminate upload or download communications
- Blink all remote annunciator zone alarm LEDs (¼ second On, ¼ second Off)

4.3.8 Process Monitored Alarm Restoral

The control panel returns to normal after all alarms have been cleared and a system reset switch has been pressed (process monitored alarm devices reset). The control panel will perform the following upon restoral of all active process monitored alarms:

- Clear the 4-character display
- Communicate the alarm restoral code programmed for the activated zone
- Store the alarm restoral message in the History File
- Turn off the piezo sounder
- Turn off appropriate zone relay output (ACM-8RF)
- Turn off any system relays (main circuit board) programmed for process alarm activation
- Output alarm restoral message to printer
- Terminate upload or download communications
- Turn off all remote annunciator zone alarm LEDs

Note that for any zone programmed for autoresettable process monitored alarm, the reset key does not need to be pressed to clear the zone.

4.3.9 OFF Normal Reporting

Removing the panel from Normal Mode and placing it into Troubleshoot, Walktest or Program Mode causes a transmission of an 'off normal' fault message. Returning the panel to Normal Mode causes a transmission of a 'return to normal' restoral message.

4.3.10 Zone Disable/Enable

The zone disable feature may be used to disable any zone in the system. While in Normal Mode or Walktest Mode, zones may be disabled if they are normal, in trouble or alarmed. *If the panel is in alarm, the silence switch must be pressed first before zone disable will function in Normal Mode.*

To disable a zone, press the **MODE** key once, (the display will go blank). You then have 10 seconds to start entering the code **3472**. Next, press the **[ENTER/STORE]** key.

- **3472** spells DISA on a Touch-Tone® phone.

Operation

A flashing lower case **d** will appear on the far left of the display. Next, press the zone number to be disabled. The number will appear on the far right display character. Press **[ENTER/STORE]**. The zone is disabled. All system annunciators will show zone troubles and general trouble status. Note that the trouble relay is activated and the trouble LED blinks.

The zone disable message will remain on the display until the zone is reenabled. To reenable a zone, press the **MODE** key once (the display will go blank). You then have 10 seconds to start entering the code **3622**. Next, press the **[ENTER/STORE]** key.

- ☛ **3622** spells ENAB on a Touch-Tone® phone.

A flashing upper case **E** will appear on the left of the display. Next, press the zone number to be enabled. The number will appear on the far right display character. Press **[ENTER/STORE]**. The zone is reenabled. Note that the trouble relay is restored to normal and the FACP trouble LED is off and all system annunciator zone trouble LEDs are off.

4.3.11 NAC (bell) Disable/Enable

The NAC/bell disable feature may be used to disable any of the four main panel NAC/bell circuits. While in Normal Mode, NACs may be disabled if they are normal, in trouble or alarmed.

To disable an NAC/bell, press the **MODE** key once (the display will go blank). You then have 10 seconds to start entering the code **3472**. Next, press the **[ENTER/STORE]** key.

- ☛ **3472** spells DISA on a Touch-Tone® phone.

A flashing lower case **d** will appear on the far left of the display. Next, press the **b** key followed by the NAC number to be disabled. The **b** and the NAC number will appear on the far right display characters. Pressing **[ENTER/STORE]** will disable the NAC. All system annunciators will show general trouble status and the main panel display will show the NAC disabled message, turn on the system trouble LED and activate relays programmed for system trouble.

The NAC disable message will remain on the display until the circuit is reenabled. To reenable an NAC, press the **MODE** key once (the display will go blank). You then have 10 seconds to start entering the code **3622**. Next, press the **[ENTER/STORE]** key.

- ☛ **3622** spells ENAB on a Touch-Tone® phone.

A flashing upper case **E** will appear on the left of the display. Next, press the **b** key followed by the NAC number to be enabled. The **b** and the NAC number will appear on the far right display characters. Pressing **[ENTER/STORE]** will reenable the NAC. Note that relays programmed as trouble are restored to normal and the FACP trouble LED is off and all system annunciator general trouble LEDs are off.

4.3.12 Fire Drill

The **DRILL** (manual evacuate) feature turns on all Notification Appliance Circuits (if programmed as enabled) and turns off the silence LED. To perform a fire drill, press the **MODE** key followed by the code **3745** then the **[ENTER/STORE]** key. The display will read **drLL**. The alarm relay is not activated. There is an option to transmit the fire drill report code to the Central Station.

- ☛ **3745** spells dril on a Touch-Tone® phone.

During a fire drill, the **SILENCE** key will silence the silenceable Notification Appliance Circuits and the **RESET** key restores the panel to normal. *All zones remain active during a fire drill.*

4.4 Central Station Communications

The control panel transmits zone and system status reports to central stations via the public switched telephone network. Two supervised telephone line connections are made to interface the control panel to the telephone lines. Two 7-foot (2.13 m) telephone cords P/N MCBL-7 may be used for this purpose.

The control panel supervises both telephone lines for proper voltage. A delay of two minutes will occur before a fault in either phone line connection is reported as a trouble. When a fault is detected, an audible trouble signal will sound, the yellow trouble LED will blink, the 4-character display will show either 'no_1' (primary phone line) or 'no_2' (secondary phone line), depending upon which telephone line has the fault, and the trouble condition will be reported to a central station over the remaining good phone line.

The control panel comes with line seizure capability provided for both the primary and secondary telephone line interfaces. Any time that the control panel needs to make a call to a central station, line seizure will disconnect any local premises phones sharing the same telephone line.

All transmissions to central stations will be sent over the Primary Central Station phone line. In the event of noisy phone lines, transmissions will be sent over the backup Secondary phone line.

Two phone numbers must be programmed, the Primary Central Station phone number and the Secondary Central Station phone number. There are three options for transmission to the central station:

- All messages are always sent to the Primary Central Station phone number with the Secondary Central Station phone number for emergency backup purposes only.
- All reports are sent to both central station phone numbers.
- Reports are sent to the first available central station phone number only.

If 10 total attempts to communicate are unsuccessful, system relays programmed for Communications Failure will be activated. The FACP will also display 'PH1' for Communicator Failure to the Primary Central Station phone number or 'PH2' for Communicator Failure to the Secondary Central Station phone number.

The MS-5210UD meets NFPA 72 National Fire Code reporting requirements for the type of signal, condition and location of the reporting premises. The general priority reporting structure is:

1. Zone Alarms and Restores
2. Zone Trouble and Restores
3. System Troubles and Restores
4. 24-hour test

Central Station Communications

The control panel is capable of reporting detailed messages depending upon the format in use. Table 4-1 shows the reporting structure for all formats.

TABLE 4-1: Format Selection Addresses (16+42) Programming Level 1

	Format # 0, 2, 4, 6, 8	Format # 3, 5, 7, 9	Format # 1, A, C	Format # B, D
Report	3+1/4+1/Standard 4+1 Express	3+1/4+1/Expanded	4+2/Standard 4+2 Express	4+2/Expanded
Alarm	SSS(S) A	SSS(S) A AAA(A) Z	SSSS AA2	SSSS AZ
Alarm Restore	SSS(S) RA	SSS(S) RA RARARA(RA) Z	SSSS RARA2	SSSS RAZ
Zone Trouble (Zone Open)	SSS(S) TZ	SSS(S) TZ TZTZTZ(TZ) Z	SSSS TZTZ2	SSSS TZZ
Zone Trouble Restore	SSS(S) RTZ	SSS(S) RTZ RTZRTZRTZ(RTZ) Z	SSSS RTZRTZ2	SSSS RTZZ
System Trouble	SSS(S) TS	SSS(S) TS TSTSTS(TS) Y	SSSS TSTS2	SSSS TSY
System Trouble Restore	SSS(S) RTS	SSS(S) RTS RTSRTSRTS(RTS) Y	SSSS RTSRTS2	SSSS RTSY
Zone Disable	SSS(S) DZ	SSS(S) DZ DZDZDZ(DZ) Z	SSSS DZDZ2	SSSS DZZ
Zone Disable Restore	SSS(S) RDZ	SSS(S) RDZ RDZRDZRDZ(RDZ) Z	SSSS RDZRDZ2	SSSS RDZZ
Bell Disable	SSS(S) DB	SSS(S) DB	SSSS DBDB2	SSSS DBDB2
Bell Disable Restore	SSS(S) RB	SSS(S) RB	SSSS RBRB2	SSSS RBRB2
Low Battery	SSS(S) L	SSS(S) L	SSSS LL2	SSSS LL2
Low Battery Restore	SSS(S) RL	SSS(S) RL	SSSS RLRL2	SSSS RLRL2
No Battery	SSS(S) N	SSS(S) N	SSSS NN2	SSSS NN2
No Battery Restore	SSS(S) RN	SSS(S) RN	SSSS RNRN2	SSSS RNRN2
AC Loss	SSS(S) P	SSS(S) P	SSSS PP2	SSSS PP2
AC Loss Restore	SSS(S) RP	SSS(S) RP	SSSS RPRP2	SSSS RPRP2
Fire Drill	SSS(S) Fd	SSS(S) Fd	SSSS FdFd2	SSSS FdFd2
Fire Drill Restore	SSS(S) RFd	SSS(S) RFd	SSSS RFdRFd2	SSSS RFdRFd2
Supervisory Condition	SSS(S) V	SSS(S) V VVV(V) Z	SSSS VV2	SSSS VZ
Supervisory Condition Restore	SSS(S) RV	SSS(S) RV RVRVRV(RV) Z	SSSS RVRV2	SSSS RVZ
Test Report	SSS(S) X	SSS(S) X	SSSS XX2	SSSS XX2
Up or Download	SSS(S) UD	SSS(S) UD	SSS UDUD2	SSS UDUD2

Refer to Table 4-2 for an explanation of each letter code in Table 4-1 .

Refer to Table 4-3 for a list of compatible receivers.

TABLE 4-2: Format Selection Address Explanation

Where:

SSS or SSSS	= Subscriber ID
A	= Alarm (1st digit)
A2	= Alarm (2nd digit)
Z	= Zone Number
RA	= Alarm Restore (1st digit)
RA2	= Alarm Restore (2nd digit)
TZ	= Zone Trouble (1st digit)
TZ2	= Zone Trouble (2nd digit)
RTZ	= Zone Trouble Restore (1st digit)
RTZ2	= Zone Trouble Restore (2nd digit)
TS	= System Trouble (1st digit)
TS2	= System Trouble (2nd digit)
RTS	= System Trouble Restore (1st digit)
RTS2	= System Trouble Restore (2nd digit)
DZ	= Zone Disable (1st digit)
DZ2	= Zone Disable (2nd digit)
RDZ	= Zone Disable Restore (1st digit)
RDZ2	= Zone Disable Restore (2nd digit)
DB	= Bell Disable (1st digit)
DB2	= Bell Disable (2nd digit)
RB	= Bell Disable Restore (1st digit)
RB2	= Bell Disable Restore (2nd digit)
L	= Low Battery (1st digit)
L2	= Low Battery (2nd digit)
RL	= Low Battery Restore (1st digit)
RL2	= Low Battery Restore (2nd digit)
N	= No Battery (1st digit)
N2	= No Battery (2nd digit)
RN	= No Battery Restore (1st digit)
RN2	= No Battery Restore (2nd digit)
P	= AC Loss (1st digit)
P2	= AC Loss (2nd digit)
RP	= AC Loss Restore (1st digit)
RP2	= AC Loss Restore (2nd digit)
FD	= Fire Drill (1st digit)
FD2	= Fire Drill (2nd digit)
RFD	= Fire Drill Restore (1st digit)
RFD2	= Fire Drill Restore (2nd digit)
V	= Supervisory Condition (1st digit)
V2	= Supervisory Condition (2nd digit)
RV	= Supervisory Condition Restore (1st digit)
RV2	= Supervisory Condition Restore (2nd digit)
X	= Test Report (1st digit)
X2	= Test Report (2nd digit)
Y	= A Trouble corresponding to the following: 1 = Earth Fault 2 = Not Used 3 = Not Used 4 = Telco Primary Line Fault 5 = Telco Secondary Line Fault 6 = NAC #1 Fault 7 = NAC #2 Fault 8 = NAC #3 Fault 9 = NAC #4 Fault A = Communication Failure to Primary Number B = Communication Failure to Secondary Number C = Printer Fault D = Annunciator Fault E = 485 Communication Failure F = System Off Normal
UD	= Upload/Download (1st digit)
UD2	= Upload/Download (2nd digit)

Note that for Expanded Reporting, the control panel automatically adds the digit corresponding to the zone number, and the second digit corresponding to any system trouble condition. Only the first digit is programmable.

4.4.1 Transmittal Priorities

The integral communicator transmits highest priority events first. Events in terms of priority are listed below in descending order:

1. Alarms (Highest Priority Level)

- Pull Stations
- Waterflow
- Smoke Detector
- Other Alarm Types

2. Supervisory Zone

3. System Troubles

- Zone/NAC Disabled
- Fire Drill
- AC Fail (after delay)
- Zonal faults
- Earth fault
- Low battery/No battery
- Telephone line fault
- Notification Appliance Circuits fault
- Communication Trouble
- Printer Trouble
- Annunciator Trouble
- EIA-485 fault
- System Off Normal
- Process Monitoring Alarm

4. Restoral Reports

- Zone Alarm
- Supervisory
- Zone(s) enabled
- Fire Drill
- AC
- Zone fault
- Earth
- Battery
- Telephone Line
- Notification Appliance Circuits
- Communication
- Printer
- Annunciator
- EIA-485
- System Off Normal
- Process Monitoring Restored

5. System Test (Lowest Priority)

Red LEDs are provided on the control panel circuit board to identify which telephone line is activated. Also, a green LED labeled 'Kissoff', will turn on whenever the control panel has successfully transmitted reports to the Central Station. The 'Kissoff' LED may turn on several times during communications with a central station.

The following table contains UL listed receivers compatible with the MS-5210UD.

TABLE 4-3: Compatible UL Listed Receivers

Format # (Addresses 16 & 42)		Ademco 685(1)	Silent Knight 9000 (2)	ITI CS-4000 (3)	FBI CP220FB	Osborne Hoffman Models 1 & 2	Radionics 6000 (6)	Radionics 6500 (5)	Sescoa 3000R (7)	Surguard MLR-2 (9)
0	4+1 Ademco Express	✓			✓					✓
1	4+2 Ademco Express	✓			✓	✓(8)				✓
2	3+1/Standard/1800/2300	✓	✓	✓	✓(4)	✓	✓	✓	✓	✓
3	3+1/Expanded/1800/2300	✓	✓	✓	✓(4)	✓			✓	✓
4	3+1/Standard/1900/1400	✓	✓		✓(4)	✓			✓	✓
5	3+1/Expanded/1900/1400	✓	✓		✓(4)	✓			✓	✓
6	4+1/Standard/1800/2300	✓	✓	✓	✓(4)	✓		✓	✓	✓
7	4+1/Expanded/1800/2300	✓	✓		✓(4)	✓			✓	✓
8	4+1/Standard/1900/1400	✓	✓		✓(4)	✓			✓	✓
9	4+1/Expanded/1900/1400	✓	✓		✓(4)	✓			✓	✓
A	4+2/Standard/1800/2300	✓	✓	✓	✓(4)	✓		✓	✓	✓
B	4+2/Expanded/1800/2300	✓	✓		✓(4)	✓			✓	✓
C	4+2/Standard/1900/1400	✓	✓		✓(4)	✓			✓	✓
D	4+2/Expanded/1900/1400	✓	✓		✓(4)	✓			✓	✓
E	Ademco Contact ID	✓			✓	✓				✓

- (1) With 685-8 Line Card with Rev 4.4d software.
- (2) With 9002 Line Card Rev 9035 software or 9032 Line Card with 9326A software.
- (3) Rev. 4.0 software.
- (4) FBI CP220FB Rec-11 Line Card with Rev 2.6 software and a memory card with Rev 3.8 software.
- (5) Model 6500 with Rev 600 software.
- (6) Model 6000 with Rev 204 software.
- (7) With Rev B control card at Rev 1.4 software and Rev C line card at Rev 1.5 software.
- (8) Model 2 only.
- (9) Version 1.62 software.

CHAPTER 5 *Servicing*

5.1 Walk Test Mode

The MS-5210UD provides the capability to perform a one-man walktest of the system without triggering the communicator, the ACM-8RF zone relays, the system annunciators or the alarm output relay. Walk Test Mode allows for testing of the 10 zones (initiating device circuits). Zones defined as Reset, Acknowledge, Silence, Drill, Autoresettable Process Monitoring or Process Monitoring are not part of the one-man walktest function. Zones defined as Pull Station, Normally-Open Contact, two or four-wire smoke detector, waterflow or supervisory are functionally tested in Walk Test Mode. An audible or silent walktest may be performed.

For an audible walktest, the first initiating device activated on a zone will cause the Notification Appliance Circuits to turn on for four seconds. Subsequent device activations on the same zone will cause the Notification Appliance Circuits to turn on for one second. Any smoke detectors that are activated will be reset. Zonal faults (open circuits) will cause the NAC to remain on steadily. Prior to entering Walk Test Mode, check to be certain that all system faults have been cleared.

Note that trouble relays will be activated while the control panel is in Walk Test Mode. Placing the control panel into Walk Test Mode will only be possible if the system has no active alarms.

Pressing the **MODE** key followed by the 4-digit code **9255** and then pressing the **[ENTER/STORE]** key will place the control panel into Walk Test Mode.

☛ **9255** spells WALK on a Touch-Tone® phone.

An **S** will be displayed on the left most character and a flashing **0** on the far right character. For audible walktest, press the **[ENTER/STORE]** key. For silent walktest, press the **1** key followed by the **[ENTER/STORE]** key.

Once in Walk Test Mode, the control panel will immediately:

- Blink the trouble LED
- Activate the trouble relay
- If an audible walktest is performed, the MS-5210UD will turn on the Notification Appliance Circuits for four seconds for the first alarm on a zone. Subsequent alarms will sound for one second. Troubles cause the NACs to remain on. For a silent walktest, all NAC outputs remain off.
- Disable the alarm relay
- Display all alarm conditions as they occur.
- Display all zone troubles as they occur.
- Display all system troubles as they occur
- Transmit 'off normal' message to Central Station(s)
- Continue to communicate any events not acknowledged at a central station prior to entering Walk Test Mode

During Walk Test Mode, zonal activity is displayed in real time as it occurs. At the end of walktesting the system, the display will show the last event that occurred. To view all events stored during walktest, use the Up arrow, Down arrow and 1st Event keys. The Down arrow key moves the walktest list to show older (previous) events. The Up arrow key moves the walktest list to show newer (more recent) events. Pressing the 1st Event key at any time will cause the display of the first event stored upon initial entry into Walk Test Mode. While in Walk Test Mode, the control panel will store up to 256 events in the Walk Test File for later recall and display. A printer may be connected to the panel during walktest. All walktest events are printed in real-time as they occur.

Zone disable mode may be used while in Walk Test Mode. Should a faulty device require repair, the zone may be disabled while the repair is performed. This allows the user to return the system to Normal Mode, enabling all other zones. This also prevents triggering of a false alarm.

History Mode

To return the control panel to Normal Mode, press the **MODE** key followed by the 4- digit code **6676** and then the **[ENTER/STORE]** key. To go to any other mode, press the **MODE** key followed by the appropriate 4-digit code and then the **[ENTER/STORE]** key. To go from silent walktest to audible walktest (or vice versa), press the **MODE** key followed by the **[ENTER/STORE]** key. **S__0** or **S__1** will appear in the display. Simply alter the '0' or '1' entry then press the **[ENTER/STORE]** key. Any delay between key entries greater than 10 seconds causes the control panel to remain in Walk Test Mode.

The control panel will automatically revert back to Normal Mode if no system activity has occurred for 60 minutes. This would include pressing any keys or activity on any zone. Exiting Walk Test Mode leaves the Walk Test file in memory such that it may be printed in Print Mode. Subsequent entries into Walk Test Mode will delete the Walk Test file.

During an audible walktest, if a device remains latched in alarm (such as a Pull Station that is not reset after activation), subsequent testing of devices on the same zone will not trigger the NACs. Be certain to reset or clear each device after testing.

Note that remote site upload or download is possible when the system is in Walk Test Mode.

5.2 History Mode

All Normal Mode events are stored in a History File list for future recall. Recall is possible via the 4-character display or via an optional printer. See the following page for a list and description of each event displayed.

This History File list is a first-in, first-out (FIFO) buffer. Only the most recent events may be called up from memory. Old events will be overwritten, i.e. pushed out of the FIFO. The number of stored events is 256. The History File is kept in E² memory. Complete power loss will not erase the list.

Pressing the **MODE** key followed by the 4-digit code **4478** and then the **[ENTER/STORE]** key places the control panel into History Mode. The most recent event will be displayed. *This will not occur if there are any active alarm conditions present. The fire protection remains active in History Mode. If an alarm occurs, the panel will automatically exit History Mode.*

☛ **4478** spells HIST on a Touch-Tone® phone.

Once in History Mode, the control panel will:

- Display all events as they occurred since the last time the History File list was cleared (the most recent event being displayed first)
- Ignore all keys except those mentioned in this section
- Continue to communicate any events not previously acknowledged at the Central Station prior to entering History Mode.

The Down arrow key moves the History File to show older (previous) events. The Up arrow key moves the History File to show newer (most recent) events.

History Mode

Shown below is the list of messages as they will appear on the display:

TABLE 5-1: History Mode Messages

<u>DISPLAY</u>	<u>EVENT</u>	<u>DISPLAY</u>	<u>EVENT</u>
ACn_	Acknowledge key pressed	F__E	Earth Fault
A__1	Zone 1 Alarm	F__A	Annunciator Fault
A__2	Zone 2 Alarm	F__P	Printer Fault
A__3	Zone 3 Alarm	F__85	Annunciator Bus Fault
A__4	Zone 4 Alarm	d__1	Zone 1 disabled
A__5	Zone 5 Alarm	d__2	Zone 2 disabled
A__6	Zone 6 Alarm	d__3	Zone 3 disabled
A__7	Zone 7 Alarm	d__4	Zone 4 disabled
A__8	Zone 8 Alarm	d__5	Zone 5 disabled
A__9	Zone 9 Alarm	d__6	Zone 6 disabled
A__10	Zone 10 Alarm	d__7	Zone 7 disabled
SU_1	Supervisory 1 Alarm	d__8	Zone 8 disabled
SU_2	Supervisory 2 Alarm	d__9	Zone 9 disabled
SU_3	Supervisory 3 Alarm	d__10	Zone 10 disabled
SU_4	Supervisory 4 Alarm	drLL	Fire Drill
SU_5	Supervisory 5 Alarm	E__1	Enable Zone 1
SU_6	Supervisory 6 Alarm	E__2	Enable Zone 2
SU_7	Supervisory 7 Alarm	E__3	Enable Zone 3
SU_8	Supervisory 8 Alarm	E__4	Enable Zone 4
SU_9	Supervisory 9 Alarm	E__5	Enable Zone 5
SU10	Supervisory 10 Alarm	E__6	Enable Zone 6
PA_1	Process Alarm Zone 1	E__7	Enable Zone 7
PA_2	Process Alarm Zone 2	E__8	Enable Zone 8
PA_3	Process Alarm Zone 3	E__9	Enable Zone 9
PA_4	Process Alarm Zone 4	E__10	Enable Zone 10
PA_5	Process Alarm Zone 5	d_b1	Disable bell 1
PA_6	Process Alarm Zone 6	d_b2	Disable bell 2
PA_7	Process Alarm Zone 7	d_b3	Disable bell 3
PA_8	Process Alarm Zone 8	d_b4	Disable bell 4
PA_9	Process Alarm Zone 9	E_b1	Enable bell 1
PA10	Process Alarm Zone 10	E_b2	Enable bell 2
AC	AC Loss	E_b3	Enable bell 3
F__1	Zone 1 Fault	E_b4	Enable bell 4
F__2	Zone 2 Fault	PH_1	Primary C.S. Number Communication Fault
F__3	Zone 3 Fault	PH_2	Secondary C.S. Number Communication Fault
F__4	Zone 4 Fault	no_b	No Battery
F__5	Zone 5 Fault	Lo_b	Low Battery
F__6	Zone 6 Fault	SILE	Silence Switch Pressed
F__7	Zone 7 Fault	SIL1	NAC/Bell #1 Silenced
F__8	Zone 8 Fault	SIL2	NAC/Bell #2 Silenced
F__9	Zone 9 Fault	SIL3	NAC/Bell #3 Silenced
F__10	Zone 10 Fault	SIL4	NAC/Bell #4 Silenced
bEL1	Bell 1 Fault (open or short)	no_1	Primary Phone Line Fault
bEL2	Bell 2 Fault (open or short)	no_2	Secondary Phone Line Fault
bEL3	Bell 3 Fault (open or short)	rES_	Reset Switch Pressed
bEL4	Bell 4 Fault (open or short)	POr_	Power On Reset (unit was powered off completely, i.e. no AC and no battery)

To erase the list from E² memory, press the **SILENCE** key twice before exiting the History Mode. A lack of keyboard activity for a period of 10 minutes will cause the control panel to return to Normal Mode. If a printer is connected to the panel, the History File will be printed upon successful entry into History Mode and a list of the most recent 256 events, time and date stamped, will print out.

Note that remote site upload or download is possible when the system is in History Mode.

5.3 Troubleshoot Mode

In this mode, system voltages may be displayed on the 4-character display. An internal voltmeter measures the voltage present at:

- ✓ zone inputs
- ✓ AC power input
- ✓ battery terminal leads
- ✓ NAC #1
- ✓ NAC #2
- ✓ NAC #3
- ✓ NAC #4
- ✓ Resettable 24 volt power

A lack of keyboard activity for a period of 20 minutes will cause the control panel to return to Normal Mode.

To enter the Troubleshoot Mode, press the **MODE** key followed by the 4-digit code **8768** and then the **[ENTER/STORE]** key.

☛ **8768** spells TROU on a Touch-Tone® phone.

Once in Troubleshoot Mode, the control panel will:

- Blink the FACP trouble LED
- Blink all remote annunciator LEDs
- Activate the FACP trouble relays if programmed for trouble operation
- Disable the Notification Appliance Circuits
- Output all troubleshoot voltage readings to external printer
- Disable the alarm relay
- Transmit the 'off normal' message to the Central Station(s)
- Continue to communicate any events not yet acknowledged at the Central Station prior to entering Troubleshoot Mode.

The **Up** arrow, **Down** arrow and **1st Event** keys do not function in Troubleshoot Mode.

5.3.1 Zones

Pressing **01** through **10**, followed by **[ENTER/STORE]**, displays the zone voltage of the selected zone. Listed below are the nominal threshold voltages for each zone:

Zone #	Normal w/EOL	Shorted	Open Circuit
1 through 10	23.5V	0.00V	25.4V

Readings will vary proportionately, depending upon system load and AC line voltage.

Troubleshoot Mode

5.3.2 AC Line

Pressing **A**, followed by **[ENTER/STORE]**, displays the AC input voltage as shown below. The AC ON indicator will turn off when the AC line voltage drops below the Low Line threshold, and the trouble LED will turn on. Following is a list of the AC line voltage range:

AC Line Voltage	Low Line	Normal	High Line
MS-5210UD:	102 VAC	115 VAC	132 VAC
MS-5210UDE:	204 VAC	220 VAC	264 VAC

5.3.3 Battery

Pressing **B**, followed by **[ENTER/STORE]**, will display the Battery Voltage. Listed below are the critical battery threshold conditions:

	Normal	Low Battery	No Battery
Battery Voltage:	27.6V	20.4V	<17.4V

Note that voltage readings should be taken after allowing 48 hours to charge depleted batteries. If batteries do not show normal readings, replace them.

IMPORTANT: The battery charger will turn off when the battery voltage drops to 17.4 VDC or less (No Battery condition). A battery with a higher voltage must be installed to turn the charger back on.

5.3.4 Telephone Lines

Pressing **C** for touchtone dialing or **D** for rotary dialing, followed by the **[ENTER/STORE]** key, causes seizure of the Primary phone line, which in turn lights the red LED, signifying Primary phone line active. After a delay of three seconds, the control panel goes off-hook to acquire a dial tone.

The control panel keypad may be used as a telephone touchpad for number dialing. Once the first digit is pressed, the display will move the **C** or **D** character one position to the left, while placing the digit to be dialed on the farthest right display position. Continue to press the phone numbers to be dialed. Successive depressions of the **[ENTER/STORE]** key hangs up and picks up the phone (places the phone on or off the hook).

The secondary phone line may be tested by pressing the **E** key for touchtone dialing or the **F** key for rotary dialing and then following the same procedure used for the primary phone line.

A handset may be temporarily connected across transformer T1 as illustrated in Figure 5-1. The handset, when connected across T1, may be used only as an amplifier/speaker and telephone with the control panel used for number dialing.

Note that remote site upload or download is not possible while testing the phone lines in this portion of Troubleshoot Mode.

FIGURE 5-1: Handset/Speaker Connection

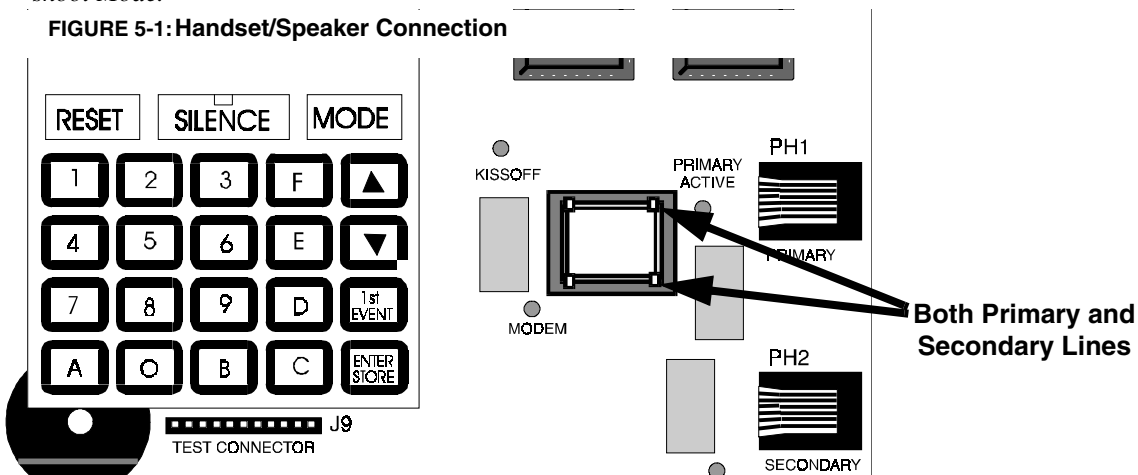

5.3.5 NACs 1, 2, 3 and 4

- Pressing **B1**, followed by **[ENTER/STORE]**, displays the voltage on NAC #1.
- Pressing **B2**, followed by **[ENTER/STORE]**, displays the voltage on NAC #2.
- Pressing **B3**, followed by **[ENTER/STORE]**, displays the voltage on NAC #3.
- Pressing **B4**, followed by **[ENTER/STORE]**, displays the voltage on NAC #4.

NAC voltage readings are nominally -2.32 volts when an EOL resistor of correct value is in place. A reading of 0.00 volts will appear for a shorted output, -4.50 volts for an open output. Intermediate readings are also possible.

5.3.6 Resettable Power

Pressing the **RESET** key, followed by **[ENTER/STORE]**, displays the resettable 24 volt power. Resettable 24 volt power must read 24 volts, + or - 10%.

5.4 Lamp Test

To perform a Lamp Test, press the **MODE** key followed by the 4-digit code **5267** and then the **[ENTER/STORE]** key. This will test all system LEDs on the FACP (except the Modem, Kissoff, Primary Active and Secondary Active LEDs). The LEDs will stay on for five seconds, then the control panel will return to Normal Mode.

- ☛ **5267** spells LAMP on a Touch-Tone® phone.

5.5 Print Mode

Refer to Figure 2-13, "Remote Printer Connections," on page 34 for proper PRT-24 Interface module connection to the main circuit board before proceeding. A printer may be temporarily or permanently connected to the panel. Program address '4' in Program Mode Level 3 to a '1' to enable printer supervision. Once enabled, normal system status as well as panel operations will be printed. If the printer connection is removed, the system trouble LEDs will blink, the system piezo sounders will pulse and the 4-character system LED display will read **F__P**.

Select Printer Mode by pressing the **MODE** key followed by the code **7746** then pressing the **[ENTER/STORE]** key. The display will read **Prn** and the following time and date stamped data will be printed:

- ✓ Entire program entries
- ✓ History File
- ✓ Walktest File
- ✓ Troubleshoot Mode voltages
- ✓ Current System Status

The fire protection remains active while in print mode. Remote site upload or download is allowed while in Print Mode. An alarm on any zone will take priority, causing the panel to exit Print Mode.

5.6 Printer Output

This section illustrates sample printouts for various panel modes.

Real Time Status

06-26-96 14:15:10

Zone 1 Verifying 2-Wire Smoke Detector Active 06-26-1996 14:15:20
 Zone 2 2-Wire Smoke Detector Active 06-26-1996 14:15:24
 Zone 2 Pull Station Active 06-26-1996 14:15:29
 Zone 3 N.O. Contact Device Active 06-26-1996 14:15:34
 Zone 4 Supervisory Active 06-26-1996 14:15:37
 Zone 5 Waterflow, Silenceable Active 06-26-1996 14:15:45
 Zone 6 Process Monitoring Active 06-26-1996 14:15:49
 System Silenced 06-26-1996 14:15:53
 NAC 1 Silence 06-26-1996 14:15:56
 NAC 2 Silence 06-26-1996 14:15:59
 Zone 1 Alarm Cleared 06-26-1996 14:16:03
 Low Battery Detected 06-26-1996 14:16:09
 Normal Battery 06-26-1996 14:16:15
 Loss of AC Power 06-26-1996 14:16:19
 AC Power Restore 06-26-1996 14:16:42
 Drill Mode Entered 06-26-1996 14:16:51
 System Reset 06-26-1996 14:17:25
 Drill Mode Cleared 06-26-1996 14:17:33

Entering Walktest Mode

06-26-96 14:32:15

Zone 2 Pull Station Active 06-26-1996 14:33:20

Entering Trouble Shoot Mode 06-26-1996 14:47:12

Trouble Shoot Mode Data

06-26-96 14:47:12

Zone 1 Voltage =25.20
 Zone 2 Voltage =25.18
 Zone 3 Voltage =25.20
 Zone 4 Voltage =25.20
 Zone 5 Voltage =25.18
 Zone 6 Voltage =25.18
 Zone 7 Voltage =25.18
 Zone 8 Voltage =25.20
 Zone 9 Voltage =25.20
 Zone 10 Voltage =25.20
 AC Line Voltage =120.9
 Battery Voltage =27.20
 NAC 1 Voltage =-2.09
 NAC 2 Voltage =-2.29
 Resettable 24 Volts =26.03

Entering Lamp Test Mode

06-26-96 15:03:10

Entering Program Mode

06-26-96 15:08:13

CHAPTER 6 *Remote Site Upload/Download*

The control panel may be programmed or interrogated off site via the public switched telephone network. Any personal computer with Windows® 3.1 or greater or Windows® 95, with a 1200 Baud Hayes™ compatible modem and Fire•Lite Upload/Download software P/N PK-5210UD, may serve as a Service Terminal. For details on the remote site upload/download software package, refer to the PK-5210UD manual. The Upload/Download software allows the following:

- Download of the entire program
- Download of an individual program item at Levels 1 - 4
- Upload of the entire program
- Upload of an individual program item at Levels 1 - 4
- Download of a single program item (such as a Central Station phone number)
- Upload of the entire program plus History File, Walktest data, current status, system voltages or time & date
- Real-time upload, either continuous or 'snapshot' (one-time), of current status or system voltages
- Execution of control panel functions: Trouble Silence, Manual Evacuate, Manual Evacuate Restore, Zone/NAC Disable, Zone/NAC Enable and Set Time & Date



CAUTION: *Changes to program entries occur as a result of the downloading process. After successful downloading, make certain to perform the following steps:*

1. *Print out all programmed data via Print Mode or manually view programmed entries and compare to intended program data.*
2. *Test all affected panel operations.*
3. *Immediately correct any problems found.*

6.1 Downloading Program: General

Any time that the control panel is downloaded, whether initiated at the jobsite or remotely, a secret code (factory default 0000) is verified between the control panel and the Service Terminal. Changing the Secret Code may only be accomplished at the Service Terminal and subsequently loaded into the control panel. Future upload or download requests cause verification of the Secret Code by the control panel before processing of data is allowed. If the Secret Code is not verified, the control panel will terminate the request immediately.

While the control panel is communicating with the Service Terminal, the panel's green Modem LED and one of the red Line Seize LEDs will remain on steady. At the conclusion of a successful download transaction, the green 'Kissoff' LED will come on steady for one second. Upon termination of communication, the green Modem LED will turn off and the red Line Seize LED will turn off.

In order to download the panel (whether initiated at the jobsite or remotely) the following must be true:

- ✓ The control panel may be in any mode of operation including Normal, Program, History, Walk Test, Print, Troubleshoot or Lamp Test. It is also possible during any of the function modes including Disable, Enable and Drill. Downloading is not possible if the communicator is active during Central Station communications or while testing the phone lines while in Troubleshoot Mode.
- ✓ There cannot be any active communications ongoing with a Central Station receiver.
- ✓ All active events must be successfully 'Kissed-off' by the Central Station(s). The Communicator must be in a standby state with no new information waiting to be transmitted to a central station.

Downloading Program: General

Two basic communication mechanisms are supported as follows:

- Download with callback - The Service Terminal calls the control panel. The control panel answers the call, confirms the calling party then hangs up. The Service Terminal then waits for a callback from the control panel. After the control panel calls the Central Station and successfully reports that a request for downloading has been received, the control panel calls the Service Terminal back. Upon secret code verification, data transfers occur. When the data transfers are completed and the Service Terminal disconnects from the control panel, the panel calls the Central Station back to confirm either successful or unsuccessful results.
- Download with callback disabled - The Service Terminal calls the control panel. No hang-up sequence occurs. Data transfers proceed.

Note that Callback enable/disable is controlled by the master user at the Service Terminal on a per call basis.

With program address location 56 set to '1' in Program Mode Level 1, anytime a download with callback is initiated, the first thing the control panel will do is one of the following:

- contact the primary Central Station
- contact both the primary and secondary Central Stations
- contact the first available Central Station phone number

Once contact has been established, the control panel will report a 'request for upload/download' message (depending upon the program entry in Program Level 4 address location 42). Following 'kiss-off' of the request by the Central Station(s), the control panel will then call the appropriate Service Terminal and begin the downloading process.

With program address location 56 set to '1' in Program Mode Level 1, anytime a download with callback disabled is initiated, the control panel and the Service Terminal will communicate and transfer data without first contacting a Central Station. When the data transfers are completed and the control panel disconnects from the Service Terminal, the control panel will call the Central Station and report one of the following conditions:

- Upload/download request received
- Upload and/or download successful
- Upload/download failed

To prevent the 'request for up/download' message(s) from being reported to the Central Station(s), make certain to leave address 56 = 0 or disable all upload/download reports back to both Central Stations. Refer to Table 3-3 through Table 3-8 for additional information.

During the downloading process, the fire protection remains active. Should a system trouble or alarm condition occur, the control panel immediately terminates downloading and processes the trouble or alarm locally and transmits the information to the Central Station(s).

6.1.1 Security Features

Remote site upload and download with the control panel has been carefully designed to include key security features to ensure proper functionality. The key features are listed and explained below.

Secret Code Verification

A secret code is stored in the control panel by a Service Terminal to prevent unauthorized access. The secret code is created at the Service Terminal by a Master user and cannot be viewed or changed by anyone other than a Master user. Viewing of the secret code is prohibited at the control panel. Prior to allowing an upload or download of data, the control panel will verify the secret code transmitted by the Service Terminal.

Time-out at Control Panel

Upon answering an incoming call on either the primary or secondary Central Station phone line, the panel will listen for a modem connection signal. If this signal is not received within 30 seconds, the panel will disconnect the call. Upon successful connection (i.e. secret code verified and callback completed, if applicable), if no communication occurs within two minutes, the panel will disconnect the call.

Downloading Initiated at Control Panel

Callback to Service Terminal

Anytime that the panel is remotely requested to allow an upload or download with callback, it will confirm the source of the incoming call, hang-up and call the calling party (Service Terminal phone number) back.

Panel Identification Number (future)

The panel identification number will be used in the future to identify the panel to the Service Terminal (when the panel calls the Service Terminal) automatically.

Calls initiated at the FACP must be coordinated at the Service Terminal manually. Note that the Service Terminal will not pickup the incoming call unless operating on the communications screen. The Service Terminal will not recognize an FACP initiated call unless the secret code is at the factory default settings.

Error Checking

As each block of data is received by the control panel, it is checked for accuracy. If an error is detected, the block is retransmitted until correct, up to a maximum of four times. If the Secret Code is not verified and four errors occur, the call is disconnected and the report that the upload/download was not successful is called to the Central Station(s).

Central Station Acknowledge

There is an option whereby the control panel will report to one or both Central Station(s) that a request for uploading or downloading has been received prior to processing the call. This is called the 'callback' option. If the Central Station(s) does not acknowledge receipt of this request, up or downloading is prohibited. If acknowledged by the Central Station(s), another message is transmitted informing the Central Station(s) of one of the following:

- downloading was successful
- uploading was successful
- uploading/downloading was not successful

Data Protection/Integrity

Options allow programming of single data entries, single programming levels (1 - 4) and the entire programming of all four levels simultaneously. Use caution when selecting programming choices and verify all entries via an upload or manual check at the FACP. Data blocks containing user programming options are protected from partial programming due to faulty phone connections, line noise and other errors.

6.2 Downloading Initiated at Control Panel

Before initiating the Download procedure, make certain that the following conditions exist:

- ✓ *control panel is in Normal Mode*
- ✓ *Central Station communications are off or Main Panel Options programming location 56 = 0*
- ✓ *the communicator is in the standby state (red Line Seize, green Modem and green Kissoff LEDs are off)*

Place the control panel into Program Mode and program one or both of the Service Terminal phone numbers. It is also advisable at this time to coordinate this call with the Service Terminal operator to allow the Service Terminal operator to easily identify the incoming call.

Exit the Program Mode and return the control panel to Normal Mode. Press the **MODE** key followed by the 4-digit code **3696** and then the [ENTER/STORE] key.

☛ **3696** spells DOWN on a Touch-Tone® phone.

The display to the far left will flash the letter **S**. Press the digit '1' for Service Terminal phone #1 or '2' for Service Terminal phone #2, followed by the [ENTER/STORE] key. The control panel will now call the appropriate Service Terminal phone number. With the Service Terminal set up with the correct download customer file and operating in the communications window, the downloading process may begin.

Downloading Initiated at a Service Terminal

Once the called Service Terminal accepts the incoming call (control panel) and verifies the secret code, the downloading process is allowed to continue. Downloading progresses until all programmed information has been successfully loaded into the control panel. Communication terminates upon the Service Terminal hanging up or upon the FACP hanging up after a two minute time-out following completion of data transfer.

6.3 Downloading Initiated at a Service Terminal

Before initiating the Download procedure, make certain that the communicator is in the standby state; red Line Seize, green Modem and green Kissoff LEDs are off.

Once an incoming call is accepted/answered by the control panel, the panel will:

1. Establish basic modem connection
2. Verify secret code
3. Verify callback vs. no callback request from the Service Terminal (if callback is requested, panel will perform steps 4 through 10; if no callback is requested, panel will perform only steps 9 and 10)
4. Identify the Service Terminal location
5. Hang-up/disconnect call
6. Call the Central Station(s) and transmit a request for upload/download message (if programmed to do so). If this message is accepted, the control panel will proceed to the next step
7. Return call to Service Terminal
8. Verify secret code
9. Begin downloading
10. Upon completion of download, call-back Central Station(s) and report a successful download or failed upload/download status (if programmed to do so)

6.4 Uploading Initiated at a Service Terminal

Items that may be uploaded from the control panel to a Service Terminal include:

- All or portions of programmed data plus the real-time clock, time and date
- Entire Walk Test data file in real-time continuous or as a 'snapshot'
- Troubleshoot system voltages in real-time continuous or as a 'snapshot'
- Entire 256 event History File
- Current system status in real-time continuous or as a 'snapshot'

Uploading is possible at any time provided the following conditions are true:

- ✓ The control panel may be in any mode of operation. Uploading is not possible if the communicator is active or while testing the phone lines while in Troubleshoot Mode
- ✓ There cannot be any active communications ongoing with the Central Station receiver
- ✓ All active events must be successfully 'kissed-off' by the Central Stations (communicator must be in a standby state with no new information waiting to be transmitted to a Central Station).

Simultaneous Data Transfers

Once an incoming call is accepted/answered by the control panel, the panel will:

1. Establish basic modem connection
2. Verify secret code
3. Verify callback vs. no callback request from the Service Terminal (if callback is requested, the panel performs steps 4 through 10; if no callback is requested, the panel performs only steps 9 and 10)
4. Identify the Service Terminal location
5. Hang-up/disconnect call
6. Call the Central Station(s) and transmit a request for upload/download message (if programmed to do so). If this message is accepted, the control panel will proceed to the next step
7. Return call to Service Terminal
8. Verify secret code
9. Begin uploading
10. Upon completion of upload, call Central Station(s) back and report a successful upload or failed upload/download status (if programmed to do so)

During the uploading process, the fire protection remains active. Should a system trouble or alarm condition occur, the control panel immediately terminates uploading and processes the trouble or alarm locally and transmits the information to the Central Station(s).

6.5 Simultaneous Data Transfers

Uploading and downloading may take place on a single telephone call. Control and selection of the data transaction is coordinated at the Service Terminal. This eliminates multiple phone calls, allows instant verification of download data files and simplifies the overall process.

Appendix A *Battery Calculations*

Use the Total Standby and Alarm Load Currents calculated in Table A-2 and Table A-3 for the following battery calculation.

TABLE A-1: Battery Calculation

Standby Load Current (amps)	X	Required Standby Time in Hours (24 or 60 Hours)	=	_____
[]		[]		
Alarm Load Current (amps)	X	Required Alarm Time in Hours (i.e. 5 min. = 0.084 hours)	=	_____
[]		[]		
Add Standby and Alarm Load for Required Ampere Hour Battery			=	_____
			X 1.2	_____
Multiply by derating factor of 1.2				

Note:

1. 12 Ampere Hour battery can be located in the backbox.
2. Batteries larger than 12 Ampere Hour, up to 18 Ampere Hour, require the BB-17F battery box.

A.1 Main Power Supply

The MS-5210UD provides regulated power for operating the fire alarm control panel, operating external devices and operating the standby battery. The power for operating external devices is limited. Use Table A-2 (standby or non-alarm) and Table A-3 (alarm) to determine if external loading is within the capabilities of the power supply.

Be certain to power 4-wire smoke detectors from TB2, Terminals 3 and 4. In Table A-2, external devices are connected to TB2 only.

TABLE A-2: Regulated Load in Standby @24 VDC .

Device Type	# of Devices		Current (amps)	=	Total Current (amps)	
Main Circuit Board	1	X	0.138	=	0.138	
LED-10IM	(1 max.)	X	0.017	=		
LED-10 Annunciator	[]	X	0.023	=		
Misc. Annunciators	[]	X	[] ¹	=		
PRT-24	(1 max.)	X	0	=		0
CAC-10F	(1 max.)	X	0.004	=		
NAC-REM	(1 max.)	X	0.002	=		
2-wire Detector Heads	[]	X	[] ¹	=		
2-wire Detector Heads	[]	X	[] ¹	=		
4-wire Detector Heads	[]	X	[] ¹	=		
4-wire Detector Heads	[]	X	[] ¹	=		
Power Supervision Relays ²	[]	X	0.025	=		
Current Draw from TB2 (nonalarm ³)				=		
Sum Column for Standby Load				=	amps	

1. Refer to the Device Compatibility Document for standby current.
2. Must use compatible listed Power Supervision Relay.
3. The total standby current must include both the resettable (TB2 Terminals 3 & 4) and nonresettable (TB2 Terminals 1 & 2) power. Caution must be taken to ensure that current drawn from these outputs during alarm does not exceed maximum ratings specified (see Table A-2).

TABLE A-3: Regulated Load in Alarm @24 VDC .

Device Type	# of Devices		Current (amps)	=	Total Current (amps)
Main Circuit Board	1	X	0.245	=	0.245 ¹
LED-10IM	(1 max.)	X	0.017	=	
LED-10 Annunciator	[]	X	0.040 ²	=	0
Misc. Annunciators	[]	X	[]	=	
PRT-24	(1 max.)	X	0	=	
CAC-10F	(1 max.)	X	0.020	=	
NAC-REM	(1 max.)	X	0.075	=	
4-wire Smoke Detector ³	[]	X	[]	=	
4-wire Smoke Detector	[]	X	[]	=	
Power Supervision Relay ⁴	[]	X	0.025	=	0
Notification Appliances ⁵	[]	X	[]	=	
Notification Appliances ⁶	[]	x	[]	=	
Current Draw from TB2 ³ (alarm current)				=	
Sum Column for Alarm Load⁷				=	amps

1. The current shown represents one zone on the Main Circuit Board in alarm. For all ten zones in alarm, the current draw increases to 0.590 amps with communicator off and 0.610 amps with communicator on.
2. The current shown represents all ten zones in alarm. One zone in alarm will draw 0.028 amps.
3. Current limitations of terminals:
 - TB2, Terminals 1 and 2 = 0.500 amps, regulated filtered, 24 VDC +/-5%, 120 Hz ripple @ 10 mV_{RMS}, nonresettable power (100 Hz ripple if MS-5210UDE)
 - TB2, Terminals 3 and 4 = 0.500 amps, regulated filtered, 24 VDC +/-5%, 120 Hz ripple @ 10 mV_{RMS}, resettable power (100 Hz ripple if MS-5210UDE)
4. Must use compatible listed Power Supervision Relay
5. Current limitation of Terminal TB4 circuits is 3.0 amps per Notification Appliance Circuit
6. Current limitations of NAC-REM module circuits is 1.5 amps per Notification Appliance Circuit.
7. Total current draw listed above cannot exceed:
 - 3.6 amps with standard transformer installed (only)
 - 6.6 amp with both the standard and optional transformers installed

Appendix B *Main Panel Options Program Sheets*

---To enter Programming Level 1, press the **MODE** key, **7764**, '1', [ENTER/STORE]

₀₀ ₀₁ ₀₂ ₀₃ ₀₄ ₀₅ ₀₆ ₀₇ ₀₈ ₀₉ ₁₀ ₁₁ ₁₂ ₁₃ ₁₄ ₁₅

Addresses 00 to 15 store the Primary Central Station Phone Number. *Enter 'F' to represent the end of number.*

₁₆ Primary Central Station Communication Format: *Enter 0 - F.*

₁₇ ₁₈ ₁₉ ₂₀ Primary Central Station Account Code: *Valid keys are 0 - F.*

₂₁ ₂₂ ₂₃ ₂₄ Primary Central Station 24-Hour Test Time. Enter military time (i.e. 1400 for 2:00 PM).

₂₅ Primary Number Test Time Interval. Enter '0' for 24-hour; '1' for 12-hour; '2' for 8-hour; '3' for 6-hour.

₂₆ ₂₇ ₂₈ ₂₉ ₃₀ ₃₁ ₃₂ ₃₃ ₃₄ ₃₅ ₃₆ ₃₇ ₃₈ ₃₉ ₄₀ ₄₁

Addresses 26 to 41 store the Secondary Central Station Phone Number. *Enter 'F' to represent the end of number.*

₄₂ Secondary Central Station Communication Format: *Enter 0 - F.*

₄₃ ₄₄ ₄₅ ₄₆ Secondary Central Station Account Code: *Valid keys are 0 - F.*

₄₇ ₄₈ ₄₉ ₅₀ Secondary Central Station 24-Hour Test Time. Enter military time (i.e. 1400 for 2:00 PM).

₅₁ Secondary Number Test Time Interval. Enter '0' for 24-hour; '1' for 12-hour; '2' for 8-hour; '3' for 6-hour.

₅₂ Alarm Presignal. Enter '0' to disable; '1' to enable.

₅₃ ₅₄ ₅₅ Alarm Presignal Delay Time. Enter 0 - 179 additional seconds (default = 120 seconds).

₅₆ Communicator/Fire Panel Selection. Enter '0' for fire panel only; '1' for fire panel/communicator operation.

₅₇ Backup Reporting. Enter '0' to report to secondary phone number as backup only; '1' to report to both primary and secondary phone number for all reports/messages; '2' reports go to first available receiver.

₅₈ Touchtone/Rotary Select for Primary Phone. Enter '0' for touchtone dialing; '1' for rotary dialing.

₅₉ Make/Break Ratio for Primary Phone. Enter '0' for 67/33 ratio; '1' for 62/38 ratio.

₆₀ Touchtone/Rotary Select for Secondary Phone. Enter '0' for touchtone dialing; '1' for rotary dialing.

₆₁ Make/Break Ratio for Secondary Phone. Enter '0' for 67/33 ratio; '1' for 62/38 ratio.

₆₂ Future use.

₆₃ Future use.

Main Panel Options Program Sheets

- ₇₃ Zone 10 Function Select. Enter '0' for 2-wire smoke detectors; '1' for pull station; '2' for normally-open contact devices; '3' for supervisory devices; '4' for supervisory devices (autoresettable); '5' for waterflow (silenceable); '6' for waterflow (nonsilenceable); '7' for process monitoring; '8' for autoresettable process monitoring; '9' for remote reset switch; 'A' for remote silence switch; 'B' for remote acknowledge switch; 'C' for remote manual evacuate (drill) switch.
- ₇₄ ₇₅ Waterflow Retard Timer. Enter 0 - 89 additional seconds.
- ₇₆ Alarm Verification. Enter '0' for no verification; '1' for verification of all 2-wire smoke zones.
- ₇₇ AC Loss Delay. Enter '0' for 6 hours; '1' for 7 hours; '2' for 8 hours; '3' for 9 hours; '4' for 10 hours; '5' for 11 hours; '6' for 12 hours; '7' for 15 hours; '8' for 16 hours; '9' for 17 hours; 'A' for 18 hours; 'B' for 19 hours; 'C' for 20 hours; 'D' for 21 hours; 'E' for 22 hours; 'F' for 23 hours.
- ₇₈ Programmable Relay #1 Definition. Enter '0' for alarm; '1' for supervisory; '2' for supervisory autoresettable; '3' for trouble; '4' for communications fail; '5' for process monitoring; '6' for process monitoring autoresettable.
- ₇₉ Programmable Relay #2 Definition. Enter '0' for alarm; '1' for supervisory; '2' for supervisory autoresettable; '3' for trouble; '4' for communications fail; '5' for process monitoring; '6' for process monitoring autoresettable.
- ₈₀ Notification Appliance Circuit #1 Selection. Enter '0' for enabled (silenceable); '1' for enable (nonsilenceable); '2' for disable.
- ₈₁ Silence Inhibit NAC #1. Enter '0' for no silence inhibit; '1' to inhibit silencing of NAC #1 for one minute.
- ₈₂ Auto Silence NAC #1. Enter '0' for no auto silence; '1' for 5 minutes; '2' for 10 minutes; '3' for 15 minutes; '4' for 20 minutes; '5' for 25 minutes; '6' for 30 minutes.
- ₈₃ Coding NAC #1. Enter '0' for steady; '1' for March Time (120 ppm); '2' for California (10 seconds On, 5 seconds Off); '3' for Temporal (½ second On, ½ second Off, ½ second On, ½ second Off, ½ second On, 1½ seconds Off).
- ₈₄ Notification Appliance Circuit #2 Selection. Enter '0' for enabled (silenceable); '1' for enable (nonsilenceable); '2' for disable.
- ₈₅ Silence Inhibit NAC #2. Enter '0' for no silence inhibit; '1' to inhibit silencing of NAC #2 for one minute.
- ₈₆ Auto Silence NAC #2. Enter '0' for no auto silence; '1' for 5 minutes; '2' for 10 minutes; '3' for 15 minutes; '4' for 20 minutes; '5' for 25 minutes; '6' for 30 minutes.
- ₈₇ Coding NAC #2. Enter '0' for steady; '1' for March Time (120 ppm); '2' for California (10 seconds On, 5 seconds Off); '3' for Temporal (½ second On, ½ second Off, ½ second On, ½ second Off, ½ second On, 1½ seconds Off).
- ₈₈ Trouble Reminder. Enter '0' to disable; '1' to enable.

Main Panel Options Programming Sheets (Factory Default Settings)

---To enter Programming Level 1, press the **MODE** key, **7764**, **'1'**, **[ENTER/STORE]**

F₀₀ **F**₀₁ **F**₀₂ **F**₀₃ **F**₀₄ **F**₀₅ **F**₀₆ **F**₀₇ **F**₀₈ **F**₀₉ **F**₁₀ **F**₁₁ **F**₁₂ **F**₁₃ **F**₁₄ **F**₁₅

Addresses 00 to 15 store the Primary Central Station Phone Number. *Enter 'F' to represent the end of number.*

E₁₆ Primary Central Station Communication Format: (*'E' for Ademco Contact ID Format.*)

0₁₇ **0**₁₈ **0**₁₉ **0**₂₀ Primary Central Station Account Code.

0₂₁ **0**₂₂ **0**₂₃ **0**₂₄ Primary Central Station 24-Hour Test Time. *0000 = 12:00 midnight.*

0₂₅ Primary Central Station Number Test Time Interval. '0' for 24-hour.

F₂₆ **F**₂₇ **F**₂₈ **F**₂₉ **F**₃₀ **F**₃₁ **F**₃₂ **F**₃₃ **F**₃₄ **F**₃₅ **F**₃₆ **F**₃₇ **F**₃₈ **F**₃₉ **F**₄₀ **F**₄₁

Addresses 26 to 41 store the Secondary Central Station Phone Number. *Enter 'F' to represent the end of number.*

E₄₂ Secondary Central Station Communication Format: (*'E' for Ademco Contact ID Format.*)

0₄₃ **0**₄₄ **0**₄₅ **0**₄₆ Secondary Central Station Account Code.

0₄₇ **0**₄₈ **0**₄₉ **0**₅₀ Secondary Central Station 24-Hour Test Time. *0000 = 12:00 midnight.*

0₅₁ Secondary Number Test Time Interval. '0' for 24-hour.

0₅₂ Alarm Presignal. '0' for no alarm presignal.

1₅₃ **2**₅₄ **0**₅₅ Alarm Presignal Delay Time. *120 second alarm presignal delay.*

0₅₆ Communicator/Fire Panel Selection. '0' for panel only operation.

0₅₇ Backup Reporting. '0' to report to Secondary Central Station phone # as backup only.

0₅₈ Touchtone/Rotary Select for Primary Phone. '0' for touchtone dialing.

0₅₉ Make/Break Ratio for Primary Phone. '0' for 67/33 ratio.

0₆₀ Touchtone/Rotary Select for Secondary Phone. '0' for touchtone dialing.

0₆₁ Make/Break Ratio for Secondary Phone. '0' for 67/33 ratio.

0₆₂ Future use. Leave default of '0'.

0₆₃ Future use. Leave default of '0'.

0₆₄ Zone 1 Function Select. '0' for 2-wire smoke detectors.

0₆₅ Zone 2 Function Select. '0' for 2-wire smoke detector.

0₆₆ Zone 3 Function Select. '0' for 2-wire smoke detectors.

Main Panel Options Program Sheets

- 0**₆₇ Zone 4 Function Select. '0' for 2-wire smoke detectors.
- 0**₆₈ Zone 5 Function Select. '0' for 2-wire smoke detectors.
- 0**₆₉ Zone 6 Function Select. '0' for 2-wire smoke detectors.
- 0**₇₀ Zone 7 Function Select. '0' for 2-wire smoke detectors.
- 0**₇₁ Zone 8 Function Select. '0' for 2-wire smoke detectors.
- 0**₇₂ Zone 9 Function Select. '0' for 2-wire smoke detectors.
- 0**₇₃ Zone 10 Function Select. '0' for 2-wire smoke detectors.
- 0**₇₄ **0**₇₅ Waterflow Retard Timer. '00' for no delay.
- 0**₇₆ Alarm Verification. '0' for no verification.
- 0**₇₇ AC Loss Delay. '0' for 6 hours.
- 0**₇₈ Programmable Relay #1 Definition. '0' for alarm.
- 3**₇₉ Programmable Relay #2 Definition. '3' for trouble.
- 0**₈₀ Notification Appliance Circuit #1 Selection. '0' for enabled (silenceable).
- 0**₈₁ Silence Inhibit NAC #1. '0' for no silence inhibit.
- 0**₈₂ Auto Silence NAC #1. '0' for no auto silence.
- 0**₈₃ Coding NAC #1. '0' for steady, no coding.
- 0**₈₄ Notification Appliance Circuit #2 Selection. '0' for enabled (silenceable).
- 0**₈₅ Silence Inhibit NAC #2. '0' for no silence inhibit.
- 0**₈₆ Auto Silence NAC #2. '0' for no auto silence.
- 0**₈₇ Coding NAC #2. '0' for steady, no coding.
- 0**₈₈ Trouble Reminder. '0' to disable, no trouble reminder.

Appendix C *Event Codes/Transmission Format Programming Sheets*

---To enter Programming Level 2, press the **MODE** key, **7764**, '2', [ENTER/STORE]

4+2 Standard and 4+2 Express Formats Primary Central Station

0	1	2	3	4	5	6	7	8	9	10	11	12
13	14	15	16	17	18	19	20	21	22	23	24	25
26	27	28	29	30	31	32	33	34	35	36	37	38
39	40	41	42	43	44	45	46	47	48	49	50	51
52	53	54	55	56	57	58	59	60	61	62	63	64
65	66	67	68	69	70	71	72	73	74	75	76	77
78	79	80	81	82	83	84	85	86	87	88	89	90
91	92	93	94	95	96	97	98	99	100	101	102	103
104	105	106	107	108	109	110	111	112	113	114	115	116
117	118	119	120	121	122	123	124	125	126	127	128	129
130	131	132	133	134	135	136	137	138	139	140	141	142
143	144	145	146	147	148	149	150	151	152	153	154	155
156	157	158	159	160	161	162	163	164	165	166	167	168
169	170	171	172	173	174	175	176	177	178	179	180	181
182	183	184	185	186	187	188	189	190	191	192	193	194
195	196	197	198	199	200	201	202	203	204	205	206	207
208	209	210	211	212	213	214	215					

Event Codes/Transmission Formats Programming Sheets for 4+2 Standard and 4+2 Express Formats Secondary Central Station

216	217	218	219	220	221	222	223	224	225	226	227	228
229	230	231	232	233	234	235	236	237	238	239	240	241
242	243	244	245	246	247	248	249	250	251	252	253	254
255	256	257	258	259	260	261	262	263	264	265	266	267
268	269	270	271	272	273	274	275	276	277	278	279	280
281	282	283	284	285	286	287	288	289	290	291	292	293
294	295	296	297	298	299	300	301	302	303	304	305	306
307	308	309	310	311	312	313	314	315	316	317	318	319
320	321	322	323	324	325	326	327	328	329	330	331	332
333	334	335	336	337	338	339	340	341	342	343	344	345
346	347	348	349	350	351	352	353	354	355	356	357	358
359	360	361	362	363	364	365	366	367	368	369	370	371
372	373	374	375	376	377	378	379	380	381	382	383	384
385	386	387	388	389	390	391	392	393	394	395	396	397
398	399	400	401	402	403	404	405	406	407	408	409	410
411	412	413	414	415	416	417	418	419	420	421	422	423
424	425	426	427	428	429	430	431					

---To enter Programming Level 2, press the **MODE** key, **7764**, '2', [ENTER/STORE]

Event Codes/Transmission Format Programming Reference Sheet (factory defaults) 4+2 Standard and 4+2 Express Formats Primary Central Station

1 ₀	1 ₁	1 ₂	2 ₃	1 ₄	3 ₅	1 ₆	4 ₇	1 ₈	5 ₉	1 ₁₀	6 ₁₁	1 ₁₂
7 ₁₃	1 ₁₄	8 ₁₅	1 ₁₆	9 ₁₇	1 ₁₈	A ₁₉	4 ₂₀	1 ₂₁	4 ₂₂	2 ₂₃	4 ₂₄	3 ₂₅
4 ₂₆	4 ₂₇	4 ₂₈	5 ₂₉	4 ₃₀	6 ₃₁	4 ₃₂	7 ₃₃	4 ₃₄	8 ₃₅	4 ₃₆	9 ₃₇	4 ₃₈
A ₃₉	9 ₄₀	7 ₄₁	9 ₄₂	2 ₄₃	F ₄₄	1 ₄₅	F ₄₆	2 ₄₇	F ₄₈	3 ₄₉	F ₅₀	4 ₅₁
F ₅₂	5 ₅₃	F ₅₄	6 ₅₅	F ₅₆	7 ₅₇	F ₅₈	8 ₅₉	F ₆₀	9 ₆₁	F ₆₂	A ₆₃	6 ₆₄
1 ₆₅	6 ₆₆	2 ₆₇	6 ₆₈	3 ₆₉	6 ₇₀	4 ₇₁	6 ₇₂	5 ₇₃	6 ₇₄	6 ₇₅	6 ₇₆	7 ₇₇
6 ₇₈	8 ₇₉	6 ₈₀	9 ₈₁	4 ₈₂	B ₈₃	4 ₈₄	C ₈₅	4 ₈₆	D ₈₇	4 ₈₈	E ₈₉	6 ₉₀
A ₉₁	6 ₉₂	B ₉₃	6 ₉₄	C ₉₅	6 ₉₆	D ₉₇	6 ₉₈	E ₉₉	6 ₁₀₀	F ₁₀₁	E ₁₀₂	1 ₁₀₃
E ₁₀₄	2 ₁₀₅	E ₁₀₆	3 ₁₀₇	E ₁₀₈	4 ₁₀₉	E ₁₁₀	5 ₁₁₁	E ₁₁₂	6 ₁₁₃	E ₁₁₄	7 ₁₁₅	E ₁₁₆
8 ₁₁₇	E ₁₁₈	9 ₁₁₉	E ₁₂₀	A ₁₂₁	5 ₁₂₂	1 ₁₂₃	5 ₁₂₄	2 ₁₂₅	5 ₁₂₆	3 ₁₂₇	5 ₁₂₈	4 ₁₂₉
5 ₁₃₀	5 ₁₃₁	5 ₁₃₂	6 ₁₃₃	5 ₁₃₄	7 ₁₃₅	5 ₁₃₆	8 ₁₃₇	5 ₁₃₈	9 ₁₃₉	5 ₁₄₀	A ₁₄₁	9 ₁₄₂
8 ₁₄₃	9 ₁₄₄	3 ₁₄₅	D ₁₄₆	1 ₁₄₇	D ₁₄₈	2 ₁₄₉	D ₁₅₀	3 ₁₅₁	D ₁₅₂	4 ₁₅₃	D ₁₅₄	5 ₁₅₅
D ₁₅₆	6 ₁₅₇	D ₁₅₈	7 ₁₅₉	D ₁₆₀	8 ₁₆₁	D ₁₆₂	9 ₁₆₃	D ₁₆₄	A ₁₆₅	A ₁₆₆	1 ₁₆₇	A ₁₆₈
2 ₁₆₉	A ₁₇₀	3 ₁₇₁	A ₁₇₂	4 ₁₇₃	A ₁₇₄	5 ₁₇₅	A ₁₇₆	6 ₁₇₇	A ₁₇₈	7 ₁₇₉	A ₁₈₀	8 ₁₈₁
A ₁₈₂	9 ₁₈₃	5 ₁₈₄	B ₁₈₅	5 ₁₈₆	C ₁₈₇	5 ₁₈₈	D ₁₈₉	5 ₁₉₀	E ₁₉₁	A ₁₉₂	A ₁₉₃	A ₁₉₄
B ₁₉₅	A ₁₉₆	C ₁₉₇	A ₁₉₈	D ₁₉₉	A ₂₀₀	E ₂₀₁	A ₂₀₂	F ₂₀₃	9 ₂₀₄	9 ₂₀₅	9 ₂₀₆	1 ₂₀₇
7 ₂₀₈	1 ₂₀₉	7 ₂₁₀	2 ₂₁₁	7 ₂₁₂	3 ₂₁₃	7 ₂₁₄	4 ₂₁₅					

Event Codes/Transmission Formats Programming Reference Sheet (factory defaults) for 4+2 Standard and 4+2 Express Formats Secondary Central Station

1 ₂₁₆	1 ₂₁₇	1 ₂₁₈	2 ₂₁₉	1 ₂₂₀	3 ₂₂₁	1 ₂₂₂	4 ₂₂₃	1 ₂₂₄	5 ₂₂₅	1 ₂₂₆	6 ₂₂₇	1 ₂₂₈
7 ₂₂₉	1 ₂₃₀	8 ₂₃₁	1 ₂₃₂	9 ₂₃₃	1 ₂₃₄	A ₂₃₅	4 ₂₃₆	1 ₂₃₇	4 ₂₃₈	2 ₂₃₉	4 ₂₄₀	3 ₂₄₁
4 ₂₄₂	4 ₂₄₃	4 ₂₄₄	5 ₂₄₅	4 ₂₄₆	6 ₂₄₇	4 ₂₄₈	7 ₂₄₉	4 ₂₅₀	8 ₂₅₁	4 ₂₅₂	9 ₂₅₃	4 ₂₅₄
A ₂₅₅	9 ₂₅₆	7 ₂₅₇	9 ₂₅₈	2 ₂₅₉	F ₂₆₀	1 ₂₆₁	F ₂₆₂	2 ₂₆₃	F ₂₆₄	3 ₂₆₅	F ₂₆₆	4 ₂₆₇
F ₂₆₈	5 ₂₆₉	F ₂₇₀	6 ₂₇₁	F ₂₇₂	7 ₂₇₃	F ₂₇₄	8 ₂₇₅	F ₂₇₆	9 ₂₇₇	F ₂₇₈	A ₂₇₉	6 ₂₈₀
1 ₂₈₁	6 ₂₈₂	2 ₂₈₃	6 ₂₈₄	3 ₂₈₅	6 ₂₈₆	4 ₂₈₇	6 ₂₈₈	5 ₂₈₉	6 ₂₉₀	6 ₂₉₁	6 ₂₉₂	7 ₂₉₃
6 ₂₉₄	8 ₂₉₅	6 ₂₉₆	9 ₂₉₇	4 ₂₉₈	B ₂₉₉	4 ₃₀₀	C ₃₀₁	4 ₃₀₂	D ₃₀₃	4 ₃₀₄	E ₃₀₅	6 ₃₀₆
A ₃₀₇	6 ₃₀₈	B ₃₀₉	6 ₃₁₀	C ₃₁₁	6 ₃₁₂	D ₃₁₃	6 ₃₁₄	E ₃₁₅	6 ₃₁₆	F ₃₁₇	E ₃₁₈	1 ₃₁₉
E ₃₂₀	2 ₃₂₁	E ₃₂₂	3 ₃₂₃	E ₃₂₄	4 ₃₂₅	E ₃₂₆	5 ₃₂₇	E ₃₂₈	6 ₃₂₉	E ₃₃₀	7 ₃₃₁	E ₃₃₂
8 ₃₃₃	E ₃₃₄	9 ₃₃₅	E ₃₃₆	A ₃₃₇	5 ₃₃₈	1 ₃₃₉	5 ₃₄₀	2 ₃₄₁	5 ₃₄₂	3 ₃₄₃	5 ₃₄₄	4 ₃₄₅
5 ₃₄₆	5 ₃₄₇	5 ₃₄₈	6 ₃₄₉	5 ₃₅₀	7 ₃₅₁	5 ₃₅₂	8 ₃₅₃	5 ₃₅₄	9 ₃₅₅	5 ₃₅₆	A ₃₅₇	9 ₃₅₈
8 ₃₅₉	9 ₃₆₀	3 ₃₆₁	D ₃₆₂	1 ₃₆₃	D ₃₆₄	2 ₃₆₅	D ₃₆₆	3 ₃₆₇	D ₃₆₈	4 ₃₆₉	D ₃₇₀	5 ₃₇₁
D ₃₇₂	6 ₃₇₃	D ₃₇₄	7 ₃₇₅	D ₃₇₆	8 ₃₇₇	D ₃₇₈	9 ₃₇₉	D ₃₈₀	A ₃₈₁	A ₃₈₂	1 ₃₈₃	A ₃₈₄
2 ₃₈₅	A ₃₈₆	3 ₃₈₇	A ₃₈₈	4 ₃₈₉	A ₃₉₀	5 ₃₉₁	A ₃₉₂	6 ₃₉₃	A ₃₉₄	7 ₃₉₅	A ₃₉₆	8 ₃₉₇
A ₃₉₈	9 ₃₉₉	5 ₄₀₀	B ₄₀₁	5 ₄₀₂	C ₄₀₃	5 ₄₀₄	D ₄₀₅	5 ₄₀₆	E ₄₀₇	A ₄₀₈	A ₄₀₉	A ₄₁₀
B ₄₁₁	A ₄₁₂	C ₄₁₃	A ₄₁₄	D ₄₁₅	A ₄₁₆	E ₄₁₇	A ₄₁₈	F ₄₁₉	9 ₄₂₀	9 ₄₂₁	9 ₄₂₂	1 ₄₂₃
7 ₄₂₄	1 ₄₂₅	7 ₄₂₆	2 ₄₂₇	7 ₄₂₈	3 ₄₂₉	7 ₄₃₀	4 ₄₃₁					

---To enter Programming Level 2, press the **MODE** key, **7764**, **'2'**, **[ENTER/STORE]**

**Event Codes/Transmission Format Programming Sheets for All 3+1, All 4+1
and 4+2 Expanded Formats Primary Central Station**

<input type="checkbox"/>	<input type="checkbox"/>	<input type="checkbox"/>	<input type="checkbox"/>	<input type="checkbox"/>	<input type="checkbox"/>	<input type="checkbox"/>	<input type="checkbox"/>	<input type="checkbox"/>	<input type="checkbox"/>	<input type="checkbox"/>	<input type="checkbox"/>	<input type="checkbox"/>
0	1	2	3	4	5	6	7	8	9	10	11	12
<input type="checkbox"/>	<input type="checkbox"/>	<input type="checkbox"/>	<input type="checkbox"/>	<input type="checkbox"/>	<input type="checkbox"/>	<input type="checkbox"/>	<input type="checkbox"/>	<input type="checkbox"/>	<input type="checkbox"/>	<input type="checkbox"/>	<input type="checkbox"/>	<input type="checkbox"/>
13	14	15	16	17	18	19	20	21	22	23	24	25
<input type="checkbox"/>	<input type="checkbox"/>	<input type="checkbox"/>	<input type="checkbox"/>	<input type="checkbox"/>	<input type="checkbox"/>	<input type="checkbox"/>	<input type="checkbox"/>	<input type="checkbox"/>	<input type="checkbox"/>	<input type="checkbox"/>	<input type="checkbox"/>	<input type="checkbox"/>
26	27	28	29	30	31	32	33	34	35	36	37	38
<input type="checkbox"/>	<input type="checkbox"/>	<input type="checkbox"/>	<input type="checkbox"/>	<input type="checkbox"/>	<input type="checkbox"/>	<input type="checkbox"/>	<input type="checkbox"/>	<input type="checkbox"/>	<input type="checkbox"/>	<input type="checkbox"/>	<input type="checkbox"/>	<input type="checkbox"/>
39	40	41	42	43	44	45	46	47	48	49	50	51
<input type="checkbox"/>	<input type="checkbox"/>	<input type="checkbox"/>	<input type="checkbox"/>	<input type="checkbox"/>	<input type="checkbox"/>	<input type="checkbox"/>	<input type="checkbox"/>	<input type="checkbox"/>	<input type="checkbox"/>	<input type="checkbox"/>	<input type="checkbox"/>	<input type="checkbox"/>
52	53	54	55	56	57	58	59	60	61	62	63	64
<input type="checkbox"/>	<input type="checkbox"/>	<input type="checkbox"/>	<input type="checkbox"/>	<input type="checkbox"/>	<input type="checkbox"/>	<input type="checkbox"/>	<input type="checkbox"/>	<input type="checkbox"/>	<input type="checkbox"/>	<input type="checkbox"/>	<input type="checkbox"/>	<input type="checkbox"/>
65	66	67	68	69	70	71	72	73	74	75	76	77
<input type="checkbox"/>	<input type="checkbox"/>	<input type="checkbox"/>	<input type="checkbox"/>	<input type="checkbox"/>	<input type="checkbox"/>	<input type="checkbox"/>	<input type="checkbox"/>	<input type="checkbox"/>	<input type="checkbox"/>	<input type="checkbox"/>	<input type="checkbox"/>	<input type="checkbox"/>
78	79	80	81	82	83	84	85	86	87	88	89	90
<input type="checkbox"/>	<input type="checkbox"/>	<input type="checkbox"/>	<input type="checkbox"/>	<input type="checkbox"/>	<input type="checkbox"/>	<input type="checkbox"/>	<input type="checkbox"/>	<input type="checkbox"/>	<input type="checkbox"/>	<input type="checkbox"/>	<input type="checkbox"/>	<input type="checkbox"/>
91	92	93	94	95	96	97	98	99	100	101	102	103
<input type="checkbox"/>	<input type="checkbox"/>	<input type="checkbox"/>	<input type="checkbox"/>									
104	105	106	107									

**Event Codes/Transmission Format Programming Sheets for All 3+1, All 4+1
and 4+2 Expanded Formats Secondary Central Station**

<input type="checkbox"/>	<input type="checkbox"/>	<input type="checkbox"/>	<input type="checkbox"/>	<input type="checkbox"/>	<input type="checkbox"/>	<input type="checkbox"/>	<input type="checkbox"/>	<input type="checkbox"/>	<input type="checkbox"/>	<input type="checkbox"/>	<input type="checkbox"/>	<input type="checkbox"/>
216	217	218	219	220	221	222	223	224	225	226	227	228
<input type="checkbox"/>	<input type="checkbox"/>	<input type="checkbox"/>	<input type="checkbox"/>	<input type="checkbox"/>	<input type="checkbox"/>	<input type="checkbox"/>	<input type="checkbox"/>	<input type="checkbox"/>	<input type="checkbox"/>	<input type="checkbox"/>	<input type="checkbox"/>	<input type="checkbox"/>
229	230	231	232	233	234	235	236	237	238	239	240	241
<input type="checkbox"/>	<input type="checkbox"/>	<input type="checkbox"/>	<input type="checkbox"/>	<input type="checkbox"/>	<input type="checkbox"/>	<input type="checkbox"/>	<input type="checkbox"/>	<input type="checkbox"/>	<input type="checkbox"/>	<input type="checkbox"/>	<input type="checkbox"/>	<input type="checkbox"/>
242	243	244	245	246	247	248	249	250	251	252	253	254
<input type="checkbox"/>	<input type="checkbox"/>	<input type="checkbox"/>	<input type="checkbox"/>	<input type="checkbox"/>	<input type="checkbox"/>	<input type="checkbox"/>	<input type="checkbox"/>	<input type="checkbox"/>	<input type="checkbox"/>	<input type="checkbox"/>	<input type="checkbox"/>	<input type="checkbox"/>
255	256	257	258	259	260	261	262	263	264	265	266	267
<input type="checkbox"/>	<input type="checkbox"/>	<input type="checkbox"/>	<input type="checkbox"/>	<input type="checkbox"/>	<input type="checkbox"/>	<input type="checkbox"/>	<input type="checkbox"/>	<input type="checkbox"/>	<input type="checkbox"/>	<input type="checkbox"/>	<input type="checkbox"/>	<input type="checkbox"/>
268	269	270	271	272	273	274	275	276	277	278	279	280
<input type="checkbox"/>	<input type="checkbox"/>	<input type="checkbox"/>	<input type="checkbox"/>	<input type="checkbox"/>	<input type="checkbox"/>	<input type="checkbox"/>	<input type="checkbox"/>	<input type="checkbox"/>	<input type="checkbox"/>	<input type="checkbox"/>	<input type="checkbox"/>	<input type="checkbox"/>
281	282	283	284	285	286	287	288	289	290	291	292	293
<input type="checkbox"/>	<input type="checkbox"/>	<input type="checkbox"/>	<input type="checkbox"/>	<input type="checkbox"/>	<input type="checkbox"/>	<input type="checkbox"/>	<input type="checkbox"/>	<input type="checkbox"/>	<input type="checkbox"/>	<input type="checkbox"/>	<input type="checkbox"/>	<input type="checkbox"/>
294	295	296	297	298	299	300	301	302	303	304	305	306
<input type="checkbox"/>	<input type="checkbox"/>	<input type="checkbox"/>	<input type="checkbox"/>	<input type="checkbox"/>	<input type="checkbox"/>	<input type="checkbox"/>	<input type="checkbox"/>	<input type="checkbox"/>	<input type="checkbox"/>	<input type="checkbox"/>	<input type="checkbox"/>	<input type="checkbox"/>
307	308	309	310	311	312	313	314	315	316	317	318	319
<input type="checkbox"/>	<input type="checkbox"/>	<input type="checkbox"/>	<input type="checkbox"/>									
320	321	322	323									

---To enter Programming Level 2, press the MODE key, 7764, '2', [ENTER/STORE]

Event Codes/Format Programming Reference Sheets Factory Defaults for All 3+1, All 4+1 and 4+2 Expanded Formats Primary Central Station

1 ₀	1 ₁	1 ₂	1 ₃	1 ₄	1 ₅	1 ₆	1 ₇	1 ₈	1 ₉	4 ₁₀	4 ₁₁	4 ₁₂
4 ₁₃	4 ₁₄	4 ₁₅	4 ₁₆	4 ₁₇	4 ₁₈	4 ₁₉	9 ₂₀	9 ₂₁	F ₂₂	F ₂₃	F ₂₄	F ₂₅
F ₂₆	F ₂₇	F ₂₈	F ₂₉	F ₃₀	F ₃₁	6 ₃₂	6 ₃₃	6 ₃₄	6 ₃₅	6 ₃₆	6 ₃₇	6 ₃₈
6 ₃₉	6 ₄₀	4 ₄₁	4 ₄₂	4 ₄₃	4 ₄₄	6 ₄₅	6 ₄₆	6 ₄₇	6 ₄₈	6 ₄₉	6 ₅₀	E ₅₁
E ₅₂	E ₅₃	E ₅₄	E ₅₅	E ₅₆	E ₅₇	E ₅₈	E ₅₉	E ₆₀	5 ₆₁	5 ₆₂	5 ₆₃	5 ₆₄
5 ₆₅	5 ₆₆	5 ₆₇	5 ₆₈	5 ₆₉	5 ₇₀	9 ₇₁	9 ₇₂	D ₇₃	D ₇₄	D ₇₅	D ₇₆	D ₇₇
D ₇₈	D ₇₉	D ₈₀	D ₈₁	D ₈₂	A ₈₃	A ₈₄	A ₈₅	A ₈₆	A ₈₇	A ₈₈	A ₈₉	A ₉₀
A ₉₁	5 ₉₂	5 ₉₃	5 ₉₄	5 ₉₅	A ₉₆	A ₉₇	A ₉₈	A ₉₉	A ₁₀₀	A ₁₀₁	9 ₁₀₂	F ₁₀₃
7 ₁₀₄	7 ₁₀₅	7 ₁₀₆	7 ₁₀₇									

Event Codes/Format Programming Reference Sheet Factory Defaults for All 3+1, All 4+1 and 4+2 Expanded Formats Secondary Central Station











































































































































































1 ₂₁₆	1 ₂₁₇	1 ₂₁₈	1 ₂₁₉	1 ₂₂₀	1 ₂₂₁	1 ₂₂₂	1 ₂₂₃	1 ₂₂₄	1 ₂₂₅	4 ₂₂₆	4 ₂₂₇	4 ₂₂₈
4 ₂₂₉	4 ₂₃₀	4 ₂₃₁	4 ₂₃₂	4 ₂₃₃	4 ₂₃₄	4 ₂₃₅	9 ₂₃₆	9 ₂₃₇	F ₂₃₈	F ₂₃₉	F ₂₄₀	F ₂₄₁
F ₂₄₂	F ₂₄₃	F ₂₄₄	F ₂₄₅	F ₂₄₆	F ₂₄₇	6 ₂₄₈	6 ₂₄₉	6 ₂₅₀	6 ₂₅₁	6 ₂₅₂	6 ₂₅₃	6 ₂₅₄
6 ₂₅₅	6 ₂₅₆	4 ₂₅₇	4 ₂₅₈	4 ₂₅₉	4 ₂₆₀	6 ₂₆₁	6 ₂₆₂	6 ₂₆₃	6 ₂₆₄	6 ₂₆₅	6 ₂₆₆	E ₂₆₇
E ₂₆₈	E ₂₆₉	E ₂₇₀	E ₂₇₁	E ₂₇₂	E ₂₇₃	E ₂₇₄	E ₂₇₅	E ₂₇₆	5 ₂₇₇	5 ₂₇₈	5 ₂₇₉	5 ₂₈₀
5 ₂₈₁	5 ₂₈₂	5 ₂₈₃	5 ₂₈₄	5 ₂₈₅	5 ₂₈₆	9 ₂₈₇	9 ₂₈₈	D ₂₈₉	D ₂₉₀	D ₂₉₁	D ₂₉₂	D ₂₉₃
D ₂₉₄	D ₂₉₅	D ₂₉₆	D ₂₉₇	D ₂₉₈	A ₂₉₉	A ₃₀₀	A ₃₀₁	A ₃₀₂	A ₃₀₃	A ₃₀₄	A ₃₀₅	A ₃₀₆
A ₃₀₇	5 ₃₀₈	5 ₃₀₉	5 ₃₁₀	5 ₃₁₁	A ₃₁₂	A ₃₁₃	A ₃₁₄	A ₃₁₅	A ₃₁₆	A ₃₁₇	9 ₃₁₈	F ₃₁₉
7 ₃₂₀	7 ₃₂₁	7 ₃₂₂	7 ₃₂₃									

---To enter Programming Level 2, press the **MODE** key, **7764**, '2', [ENTER/STORE]

Event Codes/Transmission Format Programming Sheets for Ademco Contact ID Primary Central Station

<input type="checkbox"/>	<input type="checkbox"/>	<input type="checkbox"/>	<input type="checkbox"/>	<input type="checkbox"/>	<input type="checkbox"/>	<input type="checkbox"/>	<input type="checkbox"/>	<input type="checkbox"/>	<input type="checkbox"/>	<input type="checkbox"/>	<input type="checkbox"/>	<input type="checkbox"/>
0	1	2	3	4	5	6	7	8	9	10	11	12
<input type="checkbox"/>	<input type="checkbox"/>	<input type="checkbox"/>	<input type="checkbox"/>	<input type="checkbox"/>	<input type="checkbox"/>	<input type="checkbox"/>	<input type="checkbox"/>	<input type="checkbox"/>	<input type="checkbox"/>	<input type="checkbox"/>	<input type="checkbox"/>	<input type="checkbox"/>
13	14	15	16	17	18	19	20	21	22	23	24	25
<input type="checkbox"/>	<input type="checkbox"/>	<input type="checkbox"/>	<input type="checkbox"/>	<input type="checkbox"/>	<input type="checkbox"/>	<input type="checkbox"/>	<input type="checkbox"/>	<input type="checkbox"/>	<input type="checkbox"/>	<input type="checkbox"/>	<input type="checkbox"/>	<input type="checkbox"/>
26	27	28	29	30	31	32	33	34	35	36	37	38
<input type="checkbox"/>	<input type="checkbox"/>	<input type="checkbox"/>	<input type="checkbox"/>	<input type="checkbox"/>	<input type="checkbox"/>	<input type="checkbox"/>	<input type="checkbox"/>	<input type="checkbox"/>	<input type="checkbox"/>	<input type="checkbox"/>	<input type="checkbox"/>	<input type="checkbox"/>
39	40	41	42	43	44	45	46	47	48	49	50	51
<input type="checkbox"/>	<input type="checkbox"/>	<input type="checkbox"/>	<input type="checkbox"/>	<input type="checkbox"/>	<input type="checkbox"/>	<input type="checkbox"/>	<input type="checkbox"/>	<input type="checkbox"/>	<input type="checkbox"/>	<input type="checkbox"/>	<input type="checkbox"/>	<input type="checkbox"/>
52	53	54	55	56	57	58	59	60	61	62	63	64
<input type="checkbox"/>	<input type="checkbox"/>	<input type="checkbox"/>	<input type="checkbox"/>	<input type="checkbox"/>	<input type="checkbox"/>	<input type="checkbox"/>	<input type="checkbox"/>	<input type="checkbox"/>	<input type="checkbox"/>	<input type="checkbox"/>	<input type="checkbox"/>	<input type="checkbox"/>
65	66	67	68	69	70	71	72	73	74	75	76	77
<input type="checkbox"/>	<input type="checkbox"/>	<input type="checkbox"/>	<input type="checkbox"/>	<input type="checkbox"/>	<input type="checkbox"/>	<input type="checkbox"/>	<input type="checkbox"/>	<input type="checkbox"/>	<input type="checkbox"/>	<input type="checkbox"/>	<input type="checkbox"/>	<input type="checkbox"/>
78	79	80	81	82	83	84	85	86	87	88	89	90
<input type="checkbox"/>	<input type="checkbox"/>	<input type="checkbox"/>	<input type="checkbox"/>	<input type="checkbox"/>	<input type="checkbox"/>	<input type="checkbox"/>	<input type="checkbox"/>	<input type="checkbox"/>	<input type="checkbox"/>	<input type="checkbox"/>	<input type="checkbox"/>	<input type="checkbox"/>
91	92	93	94	95	96	97	98	99	100	101	102	103
<input type="checkbox"/>	<input type="checkbox"/>	<input type="checkbox"/>	<input type="checkbox"/>	<input type="checkbox"/>	<input type="checkbox"/>	<input type="checkbox"/>	<input type="checkbox"/>	<input type="checkbox"/>	<input type="checkbox"/>	<input type="checkbox"/>	<input type="checkbox"/>	<input type="checkbox"/>
104	105	106	107	108	109	110	111	112	113	114	115	116
<input type="checkbox"/>	<input type="checkbox"/>	<input type="checkbox"/>	<input type="checkbox"/>	<input type="checkbox"/>	<input type="checkbox"/>	<input type="checkbox"/>	<input type="checkbox"/>	<input type="checkbox"/>	<input type="checkbox"/>	<input type="checkbox"/>	<input type="checkbox"/>	<input type="checkbox"/>
117	118	119	120	121	122	123	124	125	126	127	128	129
<input type="checkbox"/>	<input type="checkbox"/>	<input type="checkbox"/>	<input type="checkbox"/>	<input type="checkbox"/>	<input type="checkbox"/>	<input type="checkbox"/>	<input type="checkbox"/>	<input type="checkbox"/>	<input type="checkbox"/>	<input type="checkbox"/>	<input type="checkbox"/>	<input type="checkbox"/>
130	131	132	133	134	135	136	137	138	139	140	141	142
<input type="checkbox"/>	<input type="checkbox"/>	<input type="checkbox"/>	<input type="checkbox"/>	<input type="checkbox"/>	<input type="checkbox"/>	<input type="checkbox"/>	<input type="checkbox"/>	<input type="checkbox"/>	<input type="checkbox"/>	<input type="checkbox"/>	<input type="checkbox"/>	<input type="checkbox"/>
143	144	145	146	147	148	149	150	151	152	153	154	155
<input type="checkbox"/>	<input type="checkbox"/>	<input type="checkbox"/>	<input type="checkbox"/>	<input type="checkbox"/>	<input type="checkbox"/>	<input type="checkbox"/>	<input type="checkbox"/>	<input type="checkbox"/>	<input type="checkbox"/>	<input type="checkbox"/>	<input type="checkbox"/>	<input type="checkbox"/>
156	157	158	159	160	161	162	163	164	165	166	167	168
<input type="checkbox"/>	<input type="checkbox"/>											
169	170											

Event Codes/Transmission Format Programming Sheets for Ademco Contact ID Secondary Central Station

 216	 217	 218	 219	 220	 221	 222	 223	 224	 225	 226	 227	 228
 229	 230	 231	 232	 233	 234	 235	 236	 237	 238	 239	 240	 241
 242	 243	 244	 245	 246	 247	 248	 249	 250	 251	 252	 253	 254
 255	 256	 257	 258	 259	 260	 261	 262	 263	 264	 265	 266	 267
 268	 269	 270	 271	 272	 273	 274	 275	 276	 277	 278	 279	 280
 281	 282	 283	 284	 285	 286	 287	 288	 289	 290	 291	 292	 293
 294	 295	 296	 297	 298	 299	 300	 301	 302	 303	 304	 305	 306
 307	 308	 309	 310	 311	 312	 313	 314	 315	 316	 317	 318	 319
 320	 321	 322	 323	 324	 325	 326	 327	 328	 329	 330	 331	 332
 333	 334	 335	 336	 337	 338	 339	 340	 341	 342	 343	 344	 345
 346	 347	 348	 349	 350	 351	 352	 353	 354	 355	 356	 357	 358
 359	 360	 361	 362	 363	 364	 365	 366	 367	 368	 369	 370	 371
 372	 373	 374	 375	 376	 377	 378	 379	 380	 381	 382	 383	 384
 385	 386											

---To enter Programming Level 2, press the **MODE** key, **7764**, '2', [ENTER/STORE]

Event Codes/Transmission Format Programming Sheet Factory Default for Ademco Contact ID Primary Central Station

1 ₀	1 ₁	1 ₂	1 ₃	1 ₄	1 ₅	1 ₆	1 ₇	1 ₈	1 ₉	1 ₁₀	1 ₁₁	1 ₁₂
1 ₁₃	1 ₁₄	1 ₁₅	1 ₁₆	1 ₁₇	1 ₁₈	1 ₁₉	1 ₂₀	1 ₂₁	1 ₂₂	1 ₂₃	1 ₂₄	1 ₂₅
1 ₂₆	1 ₂₇	1 ₂₈	1 ₂₉	5 ₃₀	7 ₃₁	0 ₃₂	5 ₃₃	7 ₃₄	0 ₃₅	5 ₃₆	7 ₃₇	0 ₃₈
5 ₃₉	7 ₄₀	0 ₄₁	5 ₄₂	7 ₄₃	0 ₄₄	5 ₄₅	7 ₄₆	0 ₄₇	5 ₄₈	7 ₄₉	0 ₅₀	5 ₅₁
7 ₅₂	0 ₅₃	5 ₅₄	7 ₅₅	0 ₅₆	5 ₅₇	7 ₅₈	0 ₅₉	6 ₆₀	0 ₆₁	4 ₆₂	3 ₆₃	0 ₆₄
1 ₆₅	3 ₆₆	8 ₆₇	0 ₆₈	3 ₆₉	8 ₇₀	0 ₇₁	3 ₇₂	8 ₇₃	0 ₇₄	3 ₇₅	8 ₇₆	0 ₇₇
3 ₇₈	8 ₇₉	0 ₈₀	3 ₈₁	8 ₈₂	0 ₈₃	3 ₈₄	8 ₈₅	0 ₈₆	3 ₈₇	8 ₈₈	0 ₈₉	3 ₉₀
8 ₉₁	0 ₉₂	3 ₉₃	8 ₉₄	0 ₉₅	3 ₉₆	1 ₉₇	0 ₉₈	3 ₉₉	0 ₁₀₀	2 ₁₀₁	3 ₁₀₂	1 ₁₀₃
1 ₁₀₄	3 ₁₀₅	5 ₁₀₆	1 ₁₀₇	3 ₁₀₈	5 ₁₀₉	2 ₁₁₀	3 ₁₁₁	2 ₁₁₂	1 ₁₁₃	3 ₁₁₄	2 ₁₁₅	2 ₁₁₆
3 ₁₁₇	2 ₁₁₈	6 ₁₁₉	3 ₁₂₀	2 ₁₂₁	7 ₁₂₂	5 ₁₂₃	2 ₁₂₄	1 ₁₂₅	5 ₁₂₆	2 ₁₂₇	2 ₁₂₈	5 ₁₂₉
2 ₁₃₀	6 ₁₃₁	5 ₁₃₂	2 ₁₃₃	7 ₁₃₄	3 ₁₃₅	5 ₁₃₆	4 ₁₃₇	3 ₁₃₈	5 ₁₃₉	4 ₁₄₀	3 ₁₄₁	3 ₁₄₂
6 ₁₄₃	3 ₁₄₄	3 ₁₄₅	0 ₁₄₆	3 ₁₄₇	3 ₁₄₈	0 ₁₄₉	3 ₁₅₀	0 ₁₅₁	8 ₁₅₂	6 ₁₅₃	0 ₁₅₄	2 ₁₅₅
6 ₁₅₆	0 ₁₅₇	8 ₁₅₈	4 ₁₅₉	1 ₁₆₀	1 ₁₆₁	4 ₁₆₂	1 ₁₆₃	6 ₁₆₄	4 ₁₆₅	1 ₁₆₆	2 ₁₆₇	4 ₁₆₈
1 ₁₆₉	3 ₁₇₀											

Event Codes/Transmission Format Programming Sheet Factory Defaults for Ademco Contact ID Secondary Central Station

1 ₂₁₆	1 ₂₁₇	1 ₂₁₈	1 ₂₁₉	1 ₂₂₀	1 ₂₂₁	1 ₂₂₂	1 ₂₂₃	1 ₂₂₄	1 ₂₂₅	1 ₂₂₆	1 ₂₂₇	1 ₂₂₈
1 ₂₂₉	1 ₂₃₀	1 ₂₃₁	1 ₂₃₂	1 ₂₃₃	1 ₂₃₄	1 ₂₃₅	1 ₂₃₆	1 ₂₃₇	1 ₂₃₈	1 ₂₃₉	1 ₂₄₀	1 ₂₄₁
1 ₂₄₂	1 ₂₄₃	1 ₂₄₄	1 ₂₄₅	5 ₂₄₆	7 ₂₄₇	0 ₂₄₈	5 ₂₄₉	7 ₂₅₀	0 ₂₅₁	5 ₂₅₂	7 ₂₅₃	0 ₂₅₄
5 ₂₅₅	7 ₂₅₆	0 ₂₅₇	5 ₂₅₈	7 ₂₅₉	0 ₂₆₀	5 ₂₆₁	7 ₂₆₂	0 ₂₆₃	5 ₂₆₄	7 ₂₆₅	0 ₂₆₆	5 ₂₆₇
7 ₂₆₈	0 ₂₆₉	5 ₂₇₀	7 ₂₇₁	0 ₂₇₂	5 ₂₇₃	7 ₂₇₄	0 ₂₇₅	6 ₂₇₆	0 ₂₇₇	4 ₂₇₈	3 ₂₇₉	0 ₂₈₀
1 ₂₈₁	3 ₂₈₂	8 ₂₈₃	0 ₂₈₄	3 ₂₈₅	8 ₂₈₆	0 ₂₈₇	3 ₂₈₈	8 ₂₈₉	0 ₂₉₀	3 ₂₉₁	8 ₂₉₂	0 ₂₉₃
3 ₂₉₄	8 ₂₉₅	0 ₂₉₆	3 ₂₉₇	8 ₂₉₈	0 ₂₉₉	3 ₃₀₀	8 ₃₀₁	0 ₃₀₂	3 ₃₀₃	8 ₃₀₄	0 ₃₀₅	3 ₃₀₆
8 ₃₀₇	0 ₃₀₈	3 ₃₀₉	8 ₃₁₀	0 ₃₁₁	3 ₃₁₂	1 ₃₁₃	0 ₃₁₄	3 ₃₁₅	0 ₃₁₆	2 ₃₁₇	3 ₃₁₈	1 ₃₁₉
1 ₃₂₀	3 ₃₂₁	5 ₃₂₂	1 ₃₂₃	3 ₃₂₄	5 ₃₂₅	2 ₃₂₆	3 ₃₂₇	2 ₃₂₈	1 ₃₂₉	3 ₃₃₀	2 ₃₃₁	2 ₃₃₂
3 ₃₃₃	2 ₃₃₄	6 ₃₃₅	3 ₃₃₆	2 ₃₃₇	7 ₃₃₈	5 ₃₃₉	2 ₃₄₀	1 ₃₄₁	5 ₃₄₂	2 ₃₄₃	2 ₃₄₄	5 ₃₄₅
2 ₃₄₆	6 ₃₄₇	5 ₃₄₈	2 ₃₄₉	7 ₃₅₀	3 ₃₅₁	5 ₃₅₂	4 ₃₅₃	3 ₃₅₄	5 ₃₅₅	4 ₃₅₆	3 ₃₅₇	3 ₃₅₈
6 ₃₅₉	3 ₃₆₀	3 ₃₆₁	0 ₃₆₂	3 ₃₆₃	3 ₃₆₄	0 ₃₆₅	3 ₃₆₆	0 ₃₆₇	8 ₃₆₈	6 ₃₆₉	0 ₃₇₀	2 ₃₇₁
6 ₃₇₂	0 ₃₇₃	8 ₃₇₄	4 ₃₇₅	1 ₃₇₆	1 ₃₇₇	4 ₃₇₈	1 ₃₇₉	6 ₃₈₀	4 ₃₈₁	1 ₃₈₂	2 ₃₈₃	4 ₃₈₄
1 ₃₈₅	3 ₃₈₆											

Appendix D *Ademco Contact ID Format Event Code Descriptions*

This appendix describes the various Event Codes and their messages which are available for the Ademco Contact ID Format.

The reporting structure for the Ademco Contact ID Format is as follows:

SSS 18 QXYZ GG CCC

where

- SSSS = Four digit Subscriber ID Account Code (addresses 17 - 20 and 43 - 46)
- 18 = Identifies transmission as Contact ID to the receiver at the Central Station
- Q = Event Qualifier where 1 = New Event and 3 = New Restore
- XYZ = Event code (shown in Table 3-5 and Table 3-8)
- GG = Group number
- CCC = Zone number

Notes:

1. GG Group Number is fixed at '00' and cannot be changed.
2. CCC Zone Number is transmitted as '001' for zone one up to '010' for zone 10.

Ademco Contact ID Reporting Structure

A typical printout from a Central Station receiver (such as the Ademco 685) of alarm and trouble reports in the Ademco Contact ID Reporting Structure follows:

<u>Time</u>	<u>Date</u>	<u>Rcvr/Line ID</u>	<u>SSSS</u>	<u>QXYZ</u>	<u>GG</u>	<u>CCCC</u>
11:28	03/25	11	7777	E110	00	C001 - general fire alarm on zone one
11:28	03/25	11	7777	E111	00	C002 - smoke detector alarm on zone two
11:28	03/25	11	7777	E380	00	C003 - fault on zone three
11:28	03/25	11	7777	E570	00	C009 - Zone nine disabled
11:28	03/25	11	7777	R110	00	C001 - Zone one alarm restored
11:28	03/25	11	7777	R111	00	C002 - smoke detector zone two restored
11:28	03/25	11	7777	R380	00	C003 - zone three fault restored
11:28	03/25	11	7777	R570	00	C009 - zone nine reenabled
11:28	03/25	11	7777	E158	00	C006 - high temperature, zone six
11:28	03/25	11	7777	E151	00	C007 - gas detected, zone seven

Notes:

1. 18, which is used in the reporting structure to identify the transmission as Contact ID, is not printed out in the alarm and trouble report.
2. Q, which is the Event Qualifier for the reporting structure, is printed out in the report as an E for New Event or R for New Restore.

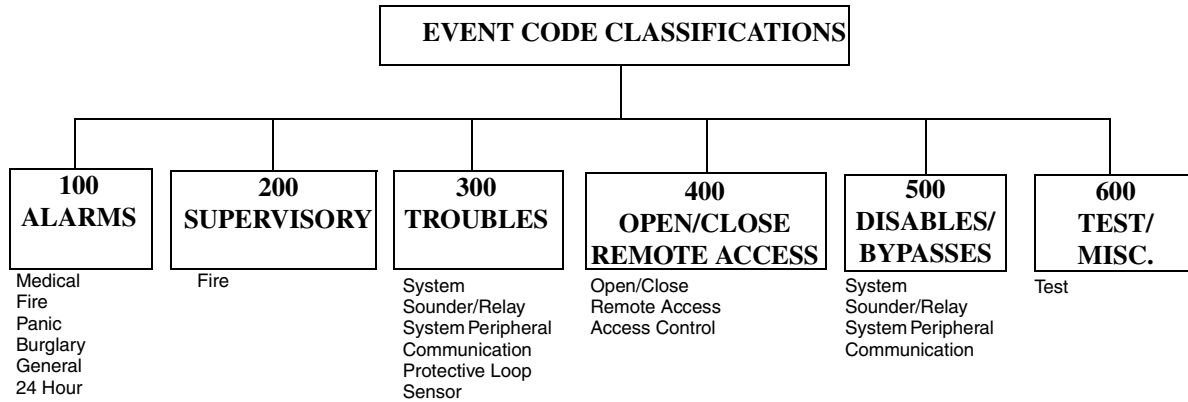

EVENT

Medical Alarms - 100

- 100 Medical
- 101 Pendant transmitter
- 102 Fail to report in

Fire Alarms - 110

- 110 Fire Alarm
- 111 Smoke
- 112 Combustion
- 113 Waterflow
- 114 Heat
- 115 Pull station
- 116 Duct
- 117 Flame
- 118 Near Alarm

Panic Alarms - 120

- 120 Panic Alarm
- 121 Duress
- 122 Silent
- 123 Audible

Burglar Alarms - 130

- 130 Burglary
- 131 Perimeter
- 132 Interior
- 133 24-Hour
- 134 Entry/Exit
- 135 Day/Night
- 136 Outdoor
- 137 Tamper
- 138 Near Alarm

General Alarms - 140

- 140 General Alarm
- 141 Polling loop open
- 142 Polling loop short
- 143 Expansion module failure
- 144 Sensor tamper
- 145 Expansion module tamper

MESSAGE

- EMERG - Personal Emergency - #
- EMERG - Personal Emergency - #
- EMERG - Fail to Check-in - #

- FIRE - Fire Alarm - #
- FIRE - Smoke Detector - #
- FIRE - Combustion - #
- FIRE - Waterflow - #
- FIRE - Heat Sensor - #
- FIRE - Pull Station - #
- FIRE - Duct Sensor - #
- FIRE - Flame Sensor - #
- FIRE - Near Alarm - #

- PANIC - Panic - #
- PANIC - Duress
- PANIC - Silent Panic - #
- PANIC - Audible Panic - #

- BURG - Burglary - #
- BURG - Perimeter - #
- BURG - Interior - #
- BURG - 24-Hour - #
- BURG - Entry/Exit - #
- BURG - Day/Night - #
- BURG - Outdoor - #
- BURG - Tamper - #
- BURG - Near Alarm - #

- ALARM - General Alarm - #
- ALARM - Polling Loop Open - #
- ALARM - Polling Loop Short - #
- ALARM - Exp. Module Fail - #
- ALARM - Sensor Tamper - #
- ALARM - Exp. Module Tamper - #

Ademco Contact ID Format Event Code Descriptions

EVENT	MESSAGE
<u>24 Hour Non-Burglary - 150 and 160</u>	
150 24-Hour Non-Burg	ALARM - 24-Hr. Non-Burg - #
151 Gas detected	ALARM - Gas Detected - #
152 Refrigeration	ALARM - Refrigeration - #
153 Loss of heat	ALARM - Heating System - #
154 Water leakage	ALARM - Eater Leakage - #
155 Foil break	ALARM - Foil Break - #
156 Day trouble	ALARM - Day Zone - #
157 Low bottled gas level	ALARM - Low Gas Level - #
158 High temp	ALARM - High Temperature - #
159 Low temp	ALARM - Low Temperature - #
161 Loss of air flow	ALARM - Air Flow - #
<u>Fire Supervisory - 200 and 210</u>	
200 Fire supervisory	SUPER. - Fire Supervisory - #
201 Low water pressure	SUPER. - Low Water Pressure - #
202 Lox CO2	SUPER. - Low CO2
203 Gate valve sensor	SUPER. - Gate Valve - #
204 Low water level	SUPER. - Low Water Level - #
205 Pump activated	SUPER. - Pump Activation - #
206 Pump failure	SUPER. - Pump Failure - #
<u>System Troubles - 300 and 310</u>	
300 System trouble	TROUBLE - System Trouble
301 AC loss	TROUBLE - AC Power
302 Low system battery	TROUBLE - System Low Battery
303 RAM checksum bad	TROUBLE - Bad RAM Checksum (Restore not applicable)
304 ROM checksum bad	TROUBLE - Bad ROM Checksum (Restore not applicable)
305 System reset	TROUBLE - System Reset (Restore not applicable)
306 Panel program changed	TROUBLE - Programming Changed (Restore not applicable)
307 Self-test failure	TROUBLE - Self Test Failure
308 System shutdown	TROUBLE - System Shutdown
309 Battery test failure	TROUBLE - Battery Test Failure
310 Ground fault	TROUBLE - Ground Fault - #
311 No battery	TROUBLE - No Battery
<u>Sounder/Relay Troubles - 320</u>	
320 Sounder/Relay	TROUBLE - Sounder Relay - #
321 Bell 1	TROUBLE - Bell/Siren #1
322 Bell 2	TROUBLE - Bell/Siren #2
323 Alarm relay	TROUBLE - Alarm Relay
324 Trouble relay	TROUBLE - Trouble Relay
325 Reversing	TROUBLE - Reversing Relay
326 Bell 3	TROUBLE - Bell/Siren #3
327 Bell 4	TROUBLE - Bell/Siren #4
<u>System Peripheral Troubles - 330 and 340</u>	
330 System peripheral	TROUBLE - Sys. Peripheral - #
331 Polling loop open	TROUBLE - Polling Loop Open
332 Polling loop short	TROUBLE - Polling Loop Short
333 Expansion module failure	TROUBLE - Exp. Module Fail - #
334 Repeater failure	TROUBLE - Repeater Failure - #
335 Local printer paper out	TROUBLE - Printer Paper Out
336 Local printer failure	TROUBLE - Local Printer

Ademco Contact ID Format Event Code Descriptions

EVENT	MESSAGE
<u>Communication Troubles - 350 and 360</u>	
350 Communication	TROUBLE - Communication Trouble
351 Telco 1 fault	TROUBLE - Phone Line #1
352 Telco 2 fault	TROUBLE - Phone Line #2
353 Long range radio xmitter fault	TROUBLE - Radio Transmitter
354 Fail to communicate	TROUBLE - Fail to Communicate
355 Loss of radio supervision	TROUBLE - Radio Supervision
356 Loss of central polling	TROUBLE - Central Radio Polling
 <u>Protection Loop Troubles - 370</u>	
370 Protection loop	TROUBLE - Protection Loop - #
371 Protection loop open	TROUBLE - Protection Loop Open - #
372 Protection loop short	TROUBLE - Protection Loop Short - #
373 Fire Trouble	TROUBLE - Fire Loop - #
 <u>Sensor Troubles - 380</u>	
380 Sensor trouble	TROUBLE - Sensor Trouble - #
381 Loss of supervision - RF	TROUBLE - RF Sensor Supervision - #
382 Loss of supervision - RPM	TROUBLE - RPM Sensor Supervision - #
383 Sensor tamper	TROUBLE - Sensor Tamper - #
384 RF transmitter low battery	TROUBLE - RF Sensor Batt. - #
 <u>Open/Close - 400</u>	
400 Open/Close	OPENING CLOSING
401 Open/Close by user	OPENING - User # CLOSING - User #
402 Group Open/Close	OPENING - Group User # CLOSING - Group User #
403 Automatic Open/Close	OPENING - Automatic CLOSING - Automatic
404 Late Open/Close	OPENING - Late CLOSING - Late
405 Deferred Open/Close	Opening not used Closing not used
406 Cancel	OPENING - Cancel Closing not used
407 Remote arm/disarm	OPENING - Remote CLOSING - Remote
408 Quick arm	Opening not applicable CLOSING - Quick arm
409 Keyswitch Open/Close	OPENING - Keyswitch CLOSING - Keyswitch
 <u>Remote Access - 410</u>	
411 Callback request made	REMOTE - Callback Requested Restore not applicable
412 Success - download/access	REMOTE - Successful Access Restore not applicable
413 Unsuccessful access	REMOTE - Unsuccessful Access Restore not applicable
414 System shutdown	REMOTE - System Shutdown
415 Dialer shutdown	REMOTE - Dialer Shutdown
416 Success - upload/access	REMOTE - Successful Access Restore not applicable
 <u>Access Control - 420</u>	
421 Access denied	ACCESS - Access Denied - User # Restore not used
422 Access report by user	ACCESS - Access Gained - User # Restore not used
 <u>System Disables - 500 and 510</u>	

Ademco Contact ID Format Event Code Descriptions

EVENT

MESSAGE

Sounder/Relay Disables - 520

520 Sounder/Relay disable	DISABLE - Sounder/Relay - #
521 Bell 1 disable	DISABLE - Bell/Siren - #1
522 Bell 2 disable	DISABLE - Bell/Siren - #2
523 Alarm relay disable	DISABLE - Alarm Relay
524 Trouble relay disable	DISABLE - Trouble Relay
525 Reversing relay disable	DISABLE - Reversing Relay
526 Bell 3 disable	DISABLE - Bell/Siren - #3
527 Bell 4 disable	DISABLE - Bell/Siren - #4

System Peripheral Disables - 530 and 540

Communication Disables - 550 and 560

551 Dialer disabled	DISABLE - Dialer Disable
552 Radio transmitter disabled	DISABLE - Radio Disable

Bypasses - 570

570 Zone bypass	BYPASS - Zone Bypass - #
571 Fire bypass	BYPASS - Fire Bypass - #
572 24-Hour zone bypass	BYPASS - 24-Hour Bypass - #
573 Burglar bypass	BYPASS - Burg. Bypass - #
574 Group bypass	BYPASS - Group Bypass - #

Test Misc. - 600

601 Manual trigger test	TEST - Manually Triggered	Restore not applicable
602 Periodic test report	TEST - Periodic	Restore not applicable
603 Periodic RF transmission	TEST - Periodic Radio	Restore not applicable
604 Fire test	TEST - Fire Test	Restore not used
605 Status report to follow	STATUS - Status Follows	Restore not applicable
606 Listen-in to follow	LISTEN - Listen-in Active	Restore not applicable
607 Walk test mode	TEST - Walk Test Mode	
608 System abnormal test	TEST - System Abnormal Test	

Appendix E *Option Modules Programming Sheets*

---To enter Programming Level 3, press the **MODE** key, **7764**, '3', [ENTER/STORE]

- ₀ CAC-10F Class A Converter Card installed. Factory default is '0' for card not installed; enter '1' to install card.
- ₁ LED-10IM EIA-485 Interface Module installed. Factory default is '0' for no module installed; enter '1' to install card.
- ₂ ₃ Annunciator or ACM-8RF maximum monitored address on EIA-485 line. Factory default is address 2 = 0, address 3 = 1. Enter the two digit address set on the switches of the annunciator or ACM-8RF Remote Relay module with the highest (maximum) address.
- ₄ Printer installed. Factory default is '0' for printer not installed; enter '1' to install printer (requires PRT-24 Printer Interface Module).
- ₅ Printer Baud Rate. Factory default is '0' for 2400 Baud; enter '1' for 4800 Baud; '2' for 9600 Baud.
- ₆ NAC/Relay Option Module installed. Factory default is '0' for no module installed; enter '1' to install module.
- ₇ Programmable Relay #3 Definition. This selection determines the panel condition which will cause Relay #3 to activate. Factory default is '1' for supervisory; enter '0' for alarm; '2' for supervisory autoresettable, '3' for trouble; '4' for communication fail; '5' for process monitoring; '6' for autoresettable process monitoring.
- ₈ Programmable Relay #4 Definition. This selection determines the panel condition which will cause Relay #4 to activate. Factory default is '4' for communication fail; enter '0' for alarm; '1' for supervisory; '2' for supervisory autoresettable; '3' for trouble; '5' for process monitoring; '6' for autoresettable process monitoring.
- ₉ NAC #3 Type Selection. Factory default is '0' for NAC #3 enabled (silenceable); enter '1' for enabled (nonsilenceable); '2' for disabled.
- ₁₀ NAC #3 Silence Inhibit. Factory default is '0' for no silence inhibit; enter '1' to inhibit silencing of NAC #3 for one minute after an alarm.
- ₁₁ NAC #3 Autosilence feature which silences signals after a selected period. Factory default is '0' for no autosilence for NAC #3; enter '1' for 5 minutes; '2' for 10 minutes; '3' for 15 minutes; '4' for 20 minutes; '5' for 25 minutes; '6' for 30 minutes.
- ₁₂ NAC #3 Signal Coding. Factory default is '0' for steady (no coding); '1' for March Time code (120 PPM); '2' for California Time code (10 secs. On, 5 secs. Off); '3' for Temporal Time code (0.5 secs. On, 0.5 secs. Off, 0.5 secs. On, 0.5 secs Off, 0.5 secs. On, 1.5 secs. Off).
- ₁₃ NAC #4 Type Selection. Factory default is '0' for NAC #4 enabled (silenceable); enter '1' for enabled (nonsilenceable); '2' for disabled.
- ₁₄ NAC #4 Silence Inhibit. Factory default is '0' for no silence inhibit; enter '1' to inhibit silencing of NAC #3 for one minute after an alarm.
- ₁₅ NAC #4 Autosilence feature which silences signals after a selected period. Factory default is '0' for no autosilence for NAC #4; enter '1' for 5 minutes; '2' for 10 minutes; '3' for 15 minutes; '4' for 20 minutes; '5' for 25 minutes; '6' for 30 minutes.
- ₁₆ NAC #4 Signal Coding. Factory default is '0' for steady (no coding); '1' for March Time code (120 PPM); '2' for California Time code (10 secs. On, 5 secs. Off); '3' for Temporal Time code (0.5 secs. On, 0.5 secs. Off, 0.5 secs. On, 0.5 secs Off, 0.5 secs. On, 1.5 secs. Off).
- ₁₇ Supervisory Annunciation. Factory default is '0' for non-Supervisory Annunciation; enter '1' for Supervisory Annunciation.

Option Module Programming Reference Sheets Factory Defaults

---To enter Programming Level 3, press the **MODE** key, **7764**, '3', **[ENTER/STORE]**

0₀ CAC-10F Class A Converter Card not installed.

0₁ LED-10IM EIA-485 Interface Module not installed. F

0₂ **1**₃ Maximum annunciator or ACM-8RF monitored address on EIA-485 line.

0₄ Printer not installed.

0₅ Printer Baud Rate. ('0' = 2400 Baud)

0₆ NAC/Relay Option Module not installed.

1₇ Programmable Relay #3 Definition. ('1' = supervisory).

4₈ Programmable Relay #4 Definition. ('4' = communication fail).

0₉ NAC #3 Type Selection. ('0' for NAC #3 enabled (silenceable).

0₁₀ NAC #3 Silence Inhibit. ('0' for no silence inhibit).

0₁₁ NAC #3 Autosilence feature which silences signals after a selected period. ('0' for no autosilence for NAC #3).

0₁₂ NAC #3 Signal Coding. ('0' for steady (no coding).

0₁₃ NAC #4 Type Selection. ('0' for NAC #4 enabled (silenceable).

0₁₄ NAC #4 Silence Inhibit. ('0' for no silence inhibit).

0₁₅ NAC #4 Autosilence feature which silences signals after a selected period. ('0' for no autosilence for NAC #4).

0₁₆ NAC #4 Signal Coding. ('0' for steady (no coding).

0₁₇ Non-Supervisory Annunciation.

Appendix F *Upload/Download Program Sheets*

---To enter Programming Level 4, press the **MODE** key, **7764**, '4', [ENTER/STORE]

₀ ₁ ₂ ₃ Panel Identification Number. Valid entries are 0 - F

₄ ₅ ₆ ₇ ₈ ₉ ₁₀ ₁₁ ₁₂ ₁₃ ₁₄ ₁₅ ₁₆ ₁₇ ₁₈ ₁₉

Service Terminal #1 Phone Number. Addresses 4 - 19 store the phone number of Service Terminal #1. Enter 'F' to represent the end of the number.

₂₀ ₂₁ Ring Count on Primary Phone Line. Enter number of rings prior to panel answering call. Valid entries are 0 - 25 (0 = no answer). Factory default is 25.

₂₂ FAX/Answer Machine, Primary Phone Line. Enter '0' for no sharing of phone line; '1' for sharing.

₂₃ ₂₄ ₂₅ ₂₆ ₂₇ ₂₈ ₂₉ ₃₀ ₃₁ ₃₂ ₃₃ ₃₄ ₃₅ ₃₆ ₃₇ ₃₈

Service Terminal #2 Phone Number. Addresses 23 - 38 store the phone number of Service Terminal #2. Enter 'F' to represent the end of the number.

₃₉ ₄₀ Ring Count on Secondary Phone Line. Enter number of rings prior to panel answering call. Valid entries are 0 - 25 (0 = no answer). Factory default is 25.

₄₁ FAX/Answer Machine, Secondary Phone Line. Enter '0' for no sharing of phone line; '1' for sharing.

₄₂ Upload/Download Backup Reporting. Enter '0' for Upload/Download reports to go to the Secondary Central Station Phone Number on backup only; '1' for Upload/Download reports to always go to the Secondary; '2' for Upload/Download reports to go to the first available Central Station phone number.

Upload/Download Programming Reference Sheets Factory Defaults

---To enter Programming Level 4, press the **MODE** key, **7764**, '4', [ENTER/STORE]

₀ ₁ ₂ ₃ Panel Identification Number.

₄ ₅ ₆ ₇ ₈ ₉ ₁₀ ₁₁ ₁₂ ₁₃ ₁₄ ₁₅ ₁₆ ₁₇ ₁₈ ₁₉

Addresses 4 - 19 store the phone number of Service Terminal #1. Enter 'F' to represent the end of the number.

₂₀ ₂₁ Ring Count on Primary Phone Line.

₂₂ FAX/Answer Machine, Primary Phone Line. ('0' for no sharing of phone line).

₂₃ ₂₄ ₂₅ ₂₆ ₂₇ ₂₈ ₂₉ ₃₀ ₃₁ ₃₂ ₃₃ ₃₄ ₃₅ ₃₆ ₃₇ ₃₈

Addresses 23 - 38 store the phone number of Service Terminal #2. Enter 'F' to represent the end of the number.

₃₉ ₄₀ Ring Count on Secondary Phone Line.

₄₁ FAX/Answer Machine, Secondary Phone Line. Enter '0' for no sharing of phone line; '1' for sharing.

₄₂ Upload/Download Backup Reporting. ('0' for Upload/Download reports to go to the Secondary Central Station Phone Number on backup only).

Appendix G *Wire Requirements*

Connecting external system accessories to the MS-5210UD main circuits must be carefully considered to ensure proper operation. It is important to use the correct type of wire, wire gauge and wire run length per each MS-5210UD circuit. Reference the chart below to specify wire requirements and limitations for each MS-5210UD.

TABLE 6-1: Wire Requirements

CIRCUIT CONNECTIONS			WIRE REQUIREMENTS	
CIRCUIT TYPE	CIRCUIT FUNCTION	WIRE TYPE AND LIMITATIONS	RECOMMENDED MAX. DISTANCE (FEET)	WIRE GAUGE
Initiating Device Circuit (power-limited)	Connects to Initiating Devices	Untwisted, unshielded wire (Do not exceed 100 ohms)	10,000 (3,000 m) 8,000 (2,400 m) 4,875 (1,480 m) 3,225 (975 m)	12 AWG (3.25 mm ²) Belden 9583 WPW999 14 AWG (2.00 mm ²) Belden 9581 WPW995 16 AWG (1.30 mm ²) Belden 9575 WPW991 18 AWG (0.75 mm ²) Belden 9574 WPW975
EIA-485 LED-10IM Inter- face Module (power-limited)	Connects to annunciator modules and relay module	Twisted, shielded pair with a characteristic impedance of 120 ohms	6,000 (1,800 m)	18 AWG (0.75 mm ²)
EIA-232 (power-limited)	PRT-24 output connects to remote printer and PC computer	Twisted, shielded pair	50 (15 m)	18 AWG (0.75 mm ²) minimum
24 VDC Regulated, resettable, nonresettable (power-limited)	Connects to annunciators and other accessories	No more than 1.2 volt drop allowed from supply source to end of any branch	Distance limitation set by 1.2 volt maximum line drop	12 AWG (3.25 mm ²) - 18 AWG (0.75 mm ²)

Appendix H *Operation and Function Modes*

TABLE 6-2: OPERATION MODES

CODE	ACTIVITY	NOTES
6676 (NORM)	Returns to normal operation	Fire protection on
7764 (PROG)	Enters Program Mode	4 levels of programming may be entered. Fire protection is off.
9255 (WALK)	Enters Walktest Mode	May select silent or audible walktest function. Fire protection is off.
4478 (HIST)	View History File	Use display or printer to view History File. Fire protection is on.
8768 (TROU)	Activates internal system voltmeter for troubleshooting and diagnosing problems	Fire protection is off while voltmeter function is enabled.
7746 (PRIN)	Sends status, history file, walktest file, troubleshoot voltages and entire programming selections to printer.	Fire protection is on. Requires PRT-24 option module.
5267 (LAMP)	Turns on all system LEDs on the main PCB (except Modem, Kissoff, Primary Active and Secondary Active LEDs) and all system annunciators for 5 seconds	Fire protection is on.
3696 (DOWN)	Allows for downloading the entire program file to the panel	Must have service terminal ready. Fire protection remains on.

TABLE 6-3: FUNCTION MODES

CODE	ACTIVITY	NOTES
3472 (DISA)	Allows disabling of any input zone or NAC	May only disable one NAC or zone at a time. Places system into trouble.
3622 (ENAB)	Allows enabling (return to normal) of any zone or NAC	May only enable one NAC or zone at a time.
3745 (DRIL)	Performs drill function by turning on all NAC outputs	Transmission of drill function to central station is defaulted to ON.
3337 (DEFP)	Reprograms all entries for Program Levels 1 through 4 to the original factory default settings	Entry of code must be performed two times in rapid succession as a safety feature. Use caution when using this feature.

Index

Numerics

1st event 66

A

AC input voltage
view 83
AC loss
see also system status 11
AC Loss Reporting Delay 47
AC power 14, 15, 26
input voltage 14
LED 68
wire requirements 14, 26
AC voltage 12
supervision 11
acknowledge 11, 19, 27, 66
see also up or down arrow key 15
software version 66
acknowledge/step 66
ACM-16ATF 19, 38
wiring 38
ACM-8RF 16, 18, 27, 35, 36
addressing 36
installation 36
programming 36
see also remote relay module 11
wiring 36
ACS Series 19
see also annunciator 12
Ademco Contact ID 54, 59
Ademco Contact ID format 109
AEM-16ATF 19
AFM-16AF 20, 38
AFM-16ATF 20, 38
alarm 15, 16, 69, 77
see also system status 11
alarm LED 68
alarm load 93
Alarm Presignal 43
Alarm Presignal Delay Timer 43
alarm verification 11, 47
Amp Hour 17, 18, 25, 91
see also battery 14
annunciator 11, 12, 16, 18, 19, 35, 37, 38
ACM-16ATF 19
AEM-16ATF 19
AFM-16AF 20
AFM-16ATF 20
LDM-32F 20
LED-10 19
Annunciator Address Programming 60
auto-silence 12

B

backbox 17
dimensions 25
mounting 23
Backup Reporting 43
battery 14, 17, 26
cabinet 14
calculations 91
charger 26
supervision 11
battery box 17, 18, 25, 91
battery charger 14, 16
capacity 14
voltage 14
battery voltage

view 83
Baud Rate 61
BB-17F
see also battery box 17, 18, 25, 91

C

cabinet 17
CAC-10F 14, 15, 16, 18, 27, 32, 60
electrical transient protection 32
installation 32
see also IDC conversion module 14
wiring 32
Calendar 11
callback 87, 88
central station 11, 16, 27, 41, 42, 86
acknowledge 88
central station communications 74
charger 26
automatic shut-off 26
Class A 15, 16, 18, 27, 32, 33
Class A converter module
see also CAC-10F 32
Class B 11, 15, 16, 18, 27, 28, 29, 32, 33
communication formats 17
communications failure 16
Communicator/Fire Panel Selection 43
computer
programming requirements 86
control panel 11
controls 15

D

data protection 88
data transfer
simultaneous 90
DC power 28
nonresettable 28
resettable 28
Default Programming 64
description of panel 11
dial tone 16
digital communicator 11, 16, 22, 30
location 30
dimensions 24
cabinet 24
DIP switch 19
display
see also indicator 15
down arrow key 15, 67
download
initiated at control panel 88
initiated at service terminal 89
see also programming 11
download process 86
DP-5210UD 17, 18
see also dress panel 12
dress panel 12, 17, 18
drill 11, 19, 27, 66

E

earth ground 26
EIA-232 16, 18, 33, 34
EIA-485 11, 16, 18, 35, 36, 60
EIA-485 Interface Module
see also LED-10IM 35
electrical transient protection
CAC-10F 32
LED-10IM 35

NAC-REM 33
End of Line Resistor
IDC 14
NAC 14
ENTER/STORE 15, 67
error checking 88
event code 11, 46
event code classification 110
Event Codes/Transmission Formats 49

F

factory default programming 39
FAX/Answer Machine 63, 64
FCC Part 68 22
FCC Registration Number 22
FCPS-24F(E) 21
applications 21
fire alarm response 69
fire alarm restoral 70
fire drill 73
fire panel/communicator 11
firmware
see also software 18
Form-A 14, 16
contact rating 14
relay 29
Form-A relay
see also relay 11
format selection addresses 75
Formats 50, 52, 54, 55, 57, 59
Form-C 16, 18
contact rating 14
relay 33, 36
Form-C relay
see also relay 11
function mode 118

H

history file 11, 12, 18
history mode 80
history mode messages 81

I

IDC 18, 27, 32
alarm current 14, 27
dummy load 28
End-of-Line Resistor 14
maximum loop resistance 14
operating voltage 14
power-limited 14
see also Initiating Device Circuit 11, 15
short circuit current 14
standby current 14, 27
IDC conversion module 14
indicators 15
see also LED 11
Initiating Device Circuit 11, 14, 18, 27
see also IDC 36
wiring 28
input circuit 27
see also IDC 15
installation 23
CAC-10F 32

K

keypad 15, 40
kissoff 15
kissoff LED 11, 16, 68

L

Lamp Driver Module
 see also LDM-32F 37
lamp test 84
LDM series annunciator 20
LDM-32F 20, 37
 programming 37
 see also annunciator 12
 wiring 37
LED 11, 19, 67
 AC power 15, 68, 69
 alarm 15, 68
 kiss-off 15, 68
 modem 15, 68
 primary phone line active 15, 68, 69
 secondary phone line active 15, 68, 69
 silence 15
 supervisory 15, 68
 system silence 68
 trouble 15, 68
LED-10 DIP switch 19
LED-10 Series 19, 35
 see also annunciator 12
LED-10IM 13, 16, 18, 19, 35, 36, 37, 60
 electrical transient protection 35
 wiring 35
LED-10IM module
 see also annunciator 12
Level Four 62
Level One
 program mode 40
Level Three 60
Level Two 49
lightning protection 26
line seizure 16
local fire panel 11, 27

M

main circuit board 17
Main Panel Options
 programming 40
make/break ratio 12
Make/Break Ratio for Primary
 Phone 44
Make/Break Ratio for Secondary
 Phone 44
messages
 history mode 81
mode 15, 66
modem 15
 requirements 86
modem LED 68
mounting 23
 semi-flush 23
 surface 23
MS-5210UD 13, 14, 26
 110 VAC input 11
MS-5210UDE 13, 14, 26
 220/240 VAC input 11

N

NAC 14, 18, 29, 32, 33, 61
 auto silence 29
 coding 29
 current 14
 current, maximum 29
 dummy load 29

 enabled/disabled 29
 End-of-Line Resistor 14
 maximum signaling current/
 circuit 14
 nonsilenceable 29
 operating voltage 14
 power-limited circuitry 14
 see also Notification Appliance
 Circuit 11
 silence inhibited 29
 silenceable 29
 wiring 29
NAC Autosilence 48, 61, 62
NAC Coding 48, 61, 62
NAC enable/disable 47, 48, 73
NAC Silence Inhibit 48, 61, 62
NAC voltage
 view 84
NAC/Relay Expander Module
 see also NAC-REM 33
NAC-REM 12, 13, 14, 16, 18, 29, 33, 61
 current rating 33
 installation 33
 wiring 33
nonresettable power 15, 16, 28
 current 15
 operating voltage 15
 standby current 15
normal mode 65, 69, 80
 return to 80
Notification Appliance Circuit 11, 12, 13, 14, 16, 18, 29, 32, 43, 69

O

off normal reporting 72
off/on hook 16
operating power 26
 connections 26
operation 65, 69
operation mode 118
Option Module Selection 60
optional modules 32
output circuit 28
 DC power 28

P

panel identification number 63, 88
panel keypad 40
panel time-out 87
piezo sounder 15, 19, 69
PK-5210UD 12, 18, 39, 86
 see also programming 11
power
 system 11
power supply 92
Primary Central Station Number 24
 Hour Test Time 42
Primary Central Station Number 24/12/
 8/6 Hour Test Time
 Interval 42
Primary Central Station Number
 Account Code 41
Primary Central Station Number
 Communication Format 41
Primary Central Station Phone
 Number 40
primary phone line 30
primary phone line active 15

primary phone line LED 68
primary power 26
primary telephone line 16
print mode 84
printer 11, 16, 33, 61
 ground fault 33
printer configuration 34
printer connection 34
printer interface module 12, 13, 33, 34
 see also PRT-24 18
printer output 85
priorities
 system status 69
process monitoring 11, 16, 27, 69, 79
 critical 11
 noncritical 11
process monitoring response 72
process monitoring restoral 72
program levels 39
 Event Codes/Transmission
 Formats 39
 Main Panel Options 39
 Option Module Selections 39
 Upload/Download 39
Program Mode 39
 entering 39
 time-out 39
program sheets
 event codes/transmission format 99
 main panel option default settings 97
 main panel options 94
 option module 114
 upload/download 116
programmer 11, 39
programming 39
 entry into 39
 factory default 39
 from PC 86
 hardware requirements 11
 required entries 39
Programming End 49
Programming Mode
 indications 40
PROM 13
PRT-24 18, 33, 34
 installation 34
 see also printer interface module 12
pull station 11, 27

R

Real Time Clock 11
Real-Time Clock and Calendar
 Programming 48
receivers - UL listed 78
regulated power 92
relay 11, 16, 18, 29, 36
 contact rating 16
 contact ratings 36
 Form-A 14
 trouble application 29
relay connections 29
relay contact rating
 Form-A 29
 Form-C 29
relay module 18
relay programming 47, 61
remote power supply
 FCPS-24F(E) 21
remote relay module 27, 36

- see also ACM-8RF 11
- Remote Station 27
- reset 15, 19, 27, 65
- resettable power 16, 27, 28
- resettable power voltage
 - view 84
- restoral reports 77
- Ring Count 63
- Ringer Equivalence 22
- RJ31X 28, 30

S

- sample printouts 85
- Secondary Central Station Number 24/
 - 12/8/6 Hour Test Time 43
- Secondary Central Station Number 24-
 - Hour Test Time 43
- Secondary Central Station Number
 - Account Code 43
- Secondary Central Station Number
 - Communication Format 42
- Secondary Central Station Phone
 - Number 42
- secondary phone line 16, 30
- secondary phone line active 15
- secondary phone line LED 68
- secondary power 26
- secret code 86
 - verification 87
- security features 87
- service terminal 18, 86
- Service Terminal Number 63
- servicing 79
- seven-segment display 15
- seven-segment LED 67
- silence 15, 19, 27, 66
- silence inhibit 12
- silence inhibit NAC 47
- smoke detector 11, 27
- smoke detector power 14, 28
 - current 14
 - operating voltage 14
 - see also resettable power 16
 - standby current 14
- software 18
- software kit
 - see also PK-5210UD 12
- standby load 92
- Style B 14, 15, 18, 27, 28, 32
- Style D 14, 15, 18, 27, 32
- Style Y 14, 16, 18, 29, 32, 33
 - see also Class B 11
- Style Z 11, 14, 16, 18, 32, 33
 - see also Class A 11
- supervision 11
 - annunciator wiring 19
 - EIA-485 18
 - telephone line 16
- supervisory 15, 16, 27, 69, 77
- Supervisory Annunciation 62
- supervisory auto-resettable circuit 11
- supervisory circuit 11
- Supervisory LED 68
- supervisory response 70
- supervisory restoral 70
- switch 19
- switch functions
 - in program mode 40
 - normal mode 65

- switches 15
- system power
 - see also power 11
- system silence LED 68
- system status 11, 12, 18, 69
- system test 77
- system trouble 69

T

- telephone 11
- telephone circuit 28, 30
 - Ringer Equivalence Number (REN) 22
 - RJ31X male connector 22
 - wiring 30
- telephone dialing
 - see also touchtone/rotary 12
- telephone line
 - supervision 16
- telephone line input voltage/current
 - supervision 11
- telephone line voltage
 - view 83
- telephone requirement 22
- tone burst 16, 17
- touchtone 16, 17
- touchtone/rotary 12
- Touchtone/Rotary Select for Primary
 - Phone 43
- Touchtone/Rotary Select for Secondary
 - Phone 44
- transformer 17, 29
 - see also XRM-24 15
- transient protection 26
- transmittal priorities 77
- trouble 15, 16, 77
 - see also system status 11
- trouble LED 68
- trouble messages 71
- trouble reminder 11, 48
- trouble response 71
- trouble restoral 71
- troubleshoot 12
- troubleshoot mode 82
- troubleshoot report 18

U

- UL power-limited wiring
 - requirements 31
- up arrow key 15, 67
- upload
 - initiated at service terminal 89
 - see also programming 11
- upload/download 86
- Upload/Download Option 62
- Upload/Download Reports 64
- upload/download software 39

V

- voltages
 - system 11

W

- walktest 12
- walktest data 11
- walktest file 12, 18
- walktest mode 79
- waterflow 12, 27
- waterflow devices 11

- Waterflow Retard Timer 46
- wire requirements 26, 117
- wiring
 - ACM-16ATF 38
 - ACM-8RF 36
 - CAC-10F 32
 - IDC 28
 - LDM-32F 37
 - LED-10IM 35
 - NAC 29
 - NAC-REM 33
 - telephone jacks 30
 - UL power-limited requirements 31

X

- XRM-24 29
- XRM-24 transformer 15, 17
- XRM-24E 29
- XRM-24E transformer 17

Z

- zone enable/disable 72
- Zone Function Selection 44, 45, 46
- zone voltages
 - view 82

Notes

Limited Warranty

The manufacturer warrants its products to be free from defects in materials and workmanship for eighteen (18) months from the date of manufacture, under normal use and service. Products are date-stamped at time of manufacture. The sole and exclusive obligation of the manufacturer is to repair or replace, at its option, free of charge for parts and labor, any part which is defective in materials or workmanship under normal use and service. For products not under the manufacturer's date-stamp control, the warranty is eighteen (18) months from date of original purchase by the manufacturer's distributor unless the installation instructions or catalog sets forth a shorter period, in which case the shorter period shall apply. This warranty is void if the product is altered, repaired, or serviced by anyone other than the manufacturer or its authorized distributors, or if there is a failure to maintain the products and systems in which they operate in a proper and workable manner. In case of defect, secure a Return Material Authorization form from our customer service department. Return product, transportation prepaid, to the manufacturer.

This writing constitutes the only warranty made by this manufacturer with respect to its products. The manufacturer does not represent that its products will prevent any loss by fire or otherwise, or that its products will in all cases provide the protection for which they are installed or intended. Buyer acknowledges that the manufacturer is not an insurer and assumes no risk for loss or damages or the cost of any inconvenience, transportation, damage, misuse, abuse, accident, or similar incident.

THE MANUFACTURER GIVES NO WARRANTY, EXPRESSED OR IMPLIED, OF MERCHANTABILITY, FITNESS FOR ANY PARTICULAR PURPOSE, OR OTHERWISE WHICH EXTEND BEYOND THE DESCRIPTION ON THE FACE HEREOF. UNDER NO CIRCUMSTANCES SHALL THE MANUFACTURER BE LIABLE FOR ANY LOSS OF OR DAMAGE TO PROPERTY, DIRECT, INCIDENTAL, OR CONSEQUENTIAL, ARISING OUT OF THE USE OF, OR INABILITY TO USE THE MANUFACTURER'S PRODUCTS. FURTHERMORE, THE MANUFACTURER SHALL NOT BE LIABLE FOR ANY PERSONAL INJURY OR DEATH WHICH MAY ARISE IN THE COURSE OF, OR AS A RESULT OF, PERSONAL, COMMERCIAL, OR INDUSTRIAL USE OF ITS PRODUCTS.

This warranty replaces all previous warranties and is the only warranty made by the manufacturer. No increase or alteration, written or verbal, of the obligation of this warranty is authorized.



World Headquarters

One Fire-Lite Place, Northford, CT 06472-1653 USA

203-484-7161 • Fax 203-484-7118

www.firelite.com

ISO 9001
CERTIFIED
ENGINEERING & MANUFACTURING